

# (1/3) Specifications

# Lithium-ion Battery Pack / LH Series

**New! : Battery Status Communication Information (BMU Data)**

(Cumulative Charge/Discharge Cycles, Product Number (PN), etc.)

Applies to products shipped after June 15, 2025.  
Earlier models can be updated via firmware.

**Applications: AMR robots, motor drives, factory automation, industrial use**

7S (25V) / 14S (50V) / LG Energy Solutions 18650 High Discharge Cell (H-class) / NCM Series

〈 Industrial / Indoor / Stationary 〉

**Model: LH-25V□□AH Series**

**LH-50V□□AH Series**

1. User Manual (Precautions) and Communication Protocol are separate documents.

Refer to "(2/3) User Manual\_ LM Lithium-ion Battery" /

"(3/3) Communication Protocol\_ LV and LM Lithium-ion Battery".

2. Application: For indoor and factory use only. Not for outdoor use in forklifts, golf carts, etc.

\*When incorporating the design, please be sure to check the CAD drawings uploaded to the website.\*

◇ The black battery shown in the above image will be changed to light gray starting early 2026, sequentially depending on the model.

◇ New products are shipped with a 30% charge. Please charge to before use.

◇ Required export documents = MSDS (UN3481, Class 9) in English/Chinese and UN38.3 Certificate --> Please request from us.

◇ Export HS Code: 8507.60.9000 / Classification: Lithium-ion rechargeable battery/Other

---

## Copyright Protection.

This user manual and product are protected by copyright law.

Part or all of this user manual and product may not be copied, reproduced, translated, or converted to electronic or machine-readable form without the prior written consent of TABOS Inc.

This user manual and product may contain typographical or technical errors, and the contents are subject to change without prior notice.

Copyright Protection.

Copyright@ 2021 ,TABOS Inc. All Rights Reserved.

---

## Revision History

■ 2025.07.10, Battery weight previously had discrepancies. Weight data for all models has been measured and corrected.

■ 2025.06.15, Added 4 items to the battery status monitoring data generated by the BMU (Battery Monitoring Unit):

- ① Cumulative Charge/Discharge Cycles, ② Product Number (PN), ③ Number of Series-Connected Cells, ④ Firmware Version.

Applies to all types of Tabos batteries shipped from 2025.06.15 onward whose model name includes the word "COM".

For all Tabos batteries shipped prior to this date, this data can also be used by updating the BMU (Battery Monitoring Unit) firmware provided by Tabos to the latest version.

This firmware can be downloaded from the Tabos website and installed directly on the battery by the user.

■ For products manufactured after January 2026: All products are equipped with OLED monitors.



# Table of Contents

## 1. Product Lineup and Individual Specifications:

(Model Name → Voltage, Wh, Ah → Certification → Applicable Motor Output)

(Motor Output→Discharge Current→Charge Current→Applicable Charger→Weight, Size→Options)

## 2. Model Name and Order Code Explanation , Accessories Guide

2-1. Model Name and Order Code Explanation

2-2. Precautions for Model Selection

2-3. Accessory Description

## 3. Common Specifications List

\*Contents: Applicable Cells → Case → Standby Power → Lifespan → Temperature → Transportation → Storage → Disposal → Wiring → Charging → BMU

## 4. Safety Management Functions (Common Specifications)

4-1. Description of Safety and Protection Functions

4-2. BMS (Battery Management Systems) Protection Action List

## 5. Battery Status Communication Device (BMU, Battery Monitoring Unit) Description

(Applies only to models with "COM" in the model name.)

(Refer to the separate 'Communication Protocol' document for communication protocol and H/W communication configuration methods.)

### 5-1. BMU Hardware Description

5-1-1. BMU Photos and Manual

5-1-2. The Ⓞ Communication Power Remote Switch does not turn the battery power ON/OFF.

5-1-3. Differences by BMU Generation (Production Year)

5-1-4. BMU Generation 1 vs. Generation 2 Identification Method

5-1-5. Brief Description of Communication Device Functions

#### **5-1-6. Explanation of Two SOC Calculation Methods**

5-1-7. SOC Calculation Characteristics of the Gauge IC and Actions to Take When Problems Occur

5-1-8. Use the remote switch contacts in conjunction with the AGV and system power.

5-1-9. Caution: If the Enable Switch above is OFF, the battery cooling fan will not operate, causing problems.

### 5-2. Battery Status Data List

## 6. Product Drawings and Photos

\* Drawings (Only representative drawings are posted) For detailed drawings of the → , download the 2D and 3D drawings from the Tabos website.

\* Battery Installation (Mounting) Direction Description.

---

# 1. Product Lineup and Individual Specifications

## ◇ Model Name Basic Structure: LH-MOTOR-□□V-□□□AH – (Case Type) / (Option Code)

- \* Models with 'COM' in the model number have a battery status communication port. COM = communication
- \* Among the certifications below, UN38.3 certification is mandatory for international shipping.
- \* Case drawings for each model are uploaded on the TABOS website. (pdf, dwg, 3D (stp, igs))
- \* The Wh values for each model are listed as identical to those recorded in the UN38.3 test reports.
- \* Application in vertical transport systems: Even when using hydraulic motors, the motor must be a speed-controllable type such as a BLDC or servo motor. Conventional hydraulic motor packs that cannot control speed cannot be used. This is because when starting a hydraulic motor directly, the excessive starting current causes the battery to output-cut due to overcurrent.
- \* Continuous discharge is possible without time limitation if the ambient temperature is low and the battery's internal temperature remains low, even when discharging for over 30 minutes at the maximum allowable discharge current for each model.

TABOS Design and Production / Made in Korea / LG Electric Vehicle Lithium-Ion Battery Cell (Cylindrical 21700) Applied, Note: Custom orders tailored to customer specifications may be possible through consultation beyond the standard specifications below.

索引 Number	Product name ( order number )	Authentication	Applied BLDC Motor Power (W) Soft_Start (ΔT ≥ 1.5 seconds)		Battery Energy (Wh)	Discharge current		Charging Current / Charger		Weight, size		Communicatio n Output
			(AMR Travel Motor) Maximum Power For intermittent occurrences	(Vertical Feed, Hydraulic Motor) Maximum Power *Caution: Hydraulic Motor No direct startup		Instantaneous Max Discharge Current	Allowable discharge Max Current(A) (30 minutes)	Allowed Charges Maximum Current(A) ( C_Rate)	Recommended maximum capacity for Tabos chargers (Increased low- current lifetime)	Weight (Kg)	Size type number (Case Drawing)	
Below: 25V battery / nominal voltage 25.8V (recommended usage voltage range: min. 24V ~ max. 29V) < 21V over discharge end voltage (EODV) and > 29.4V over charge end voltage (EOCV) >												
25V-101	lh-motor-25v-60ah-x2	UN38.3 CE (EMC)	3200	1920	1,512	240 ( 0.1 sec)	90	70 (1.2C)	1500 W (45 A)	10	X2	
25V-102	LH-MOTOR-25V-60AH-X2COM	UN38.3 CE (EMC)	3200	1920	1,512	240 ( 0.1 sec)	90	70 (1.2C)	1500 W (45 A)	10.5	X2COM	BMS Communication

索引 Number	Product name ( order number )	Authentication	Applied BLDC Motor Power (W) Soft_Start ( $\Delta T \geq 1.5$ seconds)		Battery Energy (Wh)	Discharge current		Charging Current / Charger		Weight, size		Communicatio n Output
			(AMR Travel Motor) Maximum Power For intermittent occurrences	(Vertical Feed, Hydraulic Motor) Maximum Power *Caution: Hydraulic Motor No direct startup		Instantaneous Max Discharge Current	Allowable discharge Max Current(A) (30 minutes)	Allowed Charges Maximum Current(A) ( C_Rate)	Recommended maximum capacity for Tabos chargers (Increased low- current lifetime)	Weight (Kg)	Size type number (Case Drawing)	
Below: 50V battery / nominal voltage 51.7V (recommended usage voltage range: min. 48V ~ max. 58V) < 42 V over discharge end voltage (EODV) and > 58.8 V over charge end voltage (EOCV) >												
50V-101	lh-motor-50v-30ah-w2	UN38.3 CE (EMC)	3200	1920	1,512	120 ( 2 sec)	90	35 (1.2C)	1500W (25A)	10	W2 Thin	
50V-102	LH-MOTOR-50V-30AH-W2COM	UN38.3 CE (EMC)	3200	1920	1,512	120 ( 2 sec)	90	35 (1.2C)	1500W (25A)	10.5	W2COM Thin	BMS Communication
50V-103	lh-motor-50v-45ah-w3	UN38.3 CE (EMC)	3200	2800	2,268	180 ( 2 sec)	90	55 (1.2C)	3500 W (60 A)	15	W3 Thin	
50V-104	LH-MOTOR-50V-45AH-W3COM	UN38.3 CE (EMC)	3200	2800	2,268	180 ( 2 sec)	90	55 (1.2C)	3500 W (60 A)	15.5	W3COM Thin	BMS Communication
50V-105	lh-motor-50v-60ah-x4	UN38.3 CE (EMC)	4200	3800	3,024	240 ( 2 sec)	90	70 (1.2C)	3500 W (60 A)	20	X4	
50V-106	LH-MOTOR-50V-60AH-X4COM	UN38.3 CE (EMC)	4200	3800	3,024	240 ( 2 sec)	90	70 (1.2C)	3500 W (60 A)	20.5	X4COM	BMS Communication

## 2. Model Name and Order Code Explanation, Accessories Guide

### 2-1. Model Name and Order Code Explanation

Model Name Basic Structure: LM-MOTOR-□□V-□□□AH -(③Case Type) / (④Option Code)

	①	② ( V,AH )	③ (Case)	④-1 (Vertical Mounting Bracket)	④-2 (Handle)
Model Name Example	Base Model Code			/V ----- Single-Parent Model (VX3, VX3COM) Applies only to these models. (Refer to 2D	/Handle1 /Handle2 /Handle2SM ----- Single-part model (Refer to 2D Drawing)
LH-MOTOR-50V-60AH-X4COM	LH-MOTOR-50V-60AH-X4COM				/Handle1

Note: Refer to the table below for descriptions of option codes.

No	Item	Description
①	Lithium-ion battery Cell Type	LH: Fast charge, fast discharge (High rate) Applicable lithium battery cells: up to 4~ 8C dischargeable, 1.5C rechargeable 2.5Ah cylindrical cells. Charging: 1.2C or less, (up to 50 minutes to 1 hour charge) Discharge: 2~3C or less discharge, (depending on battery pack type)
②	Nominal Voltage V Nominal Capacity AH	Battery Nominal Voltage (V) x Current Capacity (AH) 25V --> The exact nominal voltage is 25.8V 50V --> The exact nominal voltage is 51.7V  AH capacity is a value achievable when charging and discharging at 0.2C or less at room temperature (20°C). Charging or discharging faster than this will result in a lower AH value.

No	Item	Description
<p>③- 1</p>	<p>Case Types</p>	<p>[Note1]: Even if voltage and current characteristics differ, cases with the same model number have identical external dimensions (size, shape).            [Note2]: Models with "COM" indicate a status communication port. The case length is 40mm longer.</p> <p>◇ <b>X-type case: Steel plate case, height approx. 145mm / VX□COM</b>            V = Vehicle battery case, X = Tall case, □ = Number of battery modules</p> <p>VX2COM: with 2 battery modules installed,            VX3COM: Equipped with 3 battery modules; battery width is 3/2 larger than VX2.</p> <p>◇ <b>W-type case: Steel plate case, height approx. 88mm / VW□COM</b>            V = Vehicle battery case, W = Wide type (Slim type), □ = Number of battery modules</p> <p>VW2COM: Equipped with 2 battery modules,            VW3COM: Equipped with 3 battery modules. Battery width is 3/2 larger than VW2.</p>
<p>③- 2</p>	<p>COM Communicati on Installation Type</p>	<p>◇ Models with COM suffix: Presence of battery status communication port (optional)            * COM = Stands for Communication for battery status transmission</p> <p>◇ Function: Transmits battery status via the communication port.</p> <p>◇ Status Display Information: Remaining charge (SOC), health (SOH), battery capacity (Ah, Wh), temperature,            Estimated charging time, estimated discharging time, etc.</p> <p>◇ Supports all 4 communication methods (user selects port and switch)</p> <p>1) Serial Communication: RS232C / RS485 / RS422            → Specifications of the communication output connector mounted on the battery: Dsub 9-pin male.</p> <p>2) Parallel Communication: CAN            → Communication output connector specifications mounted on the battery: Dsub 9-pin female.</p> <p>[Note1]: CAN is recommended as it is highly resistant to noise; RS485/RS422 communication is recommended as a secondary option.</p>

## 2-2. Considerations for Model Selection

◇ Using a high-voltage battery (50V) can reduce battery heat generation and charge/discharge currents, allow for thinner wiring, and enable driving of higher-output motors.

1) For 25V batteries: The terminal block's rated current capacity is 100A, but for safety margins, the allowable current is limited to 90A, imposing constraints on increasing battery charging and discharging currents.

For this reason, 50V batteries are often advantageous for high-capacity applications.

2) For 50V batteries: Compared to a 25V battery of the same capacity, the current is reduced to half, providing more leeway to increase the charging and discharging currents. Therefore, each battery can drive a motor with a higher output.

◇ If a single battery cannot handle the maximum motor output, connect 2 to 3 batteries in parallel.

◇ The actual usable charging capacity is determined by the maximum charging voltage of the applied charger.

**Notes on battery capacity selection**

1) For 25V batteries: Charging at 28V results in approximately 80% SOC, charging at 29V results in approximately 95% SOC.





2) For 50V batteries: Charging at 56V results in approximately 88% SOC, charging at 58V results in approximately 94% SOC

\* SOC (State Of Charge): Charge level.

◇ If a higher current than the battery's maximum charge/discharge current is required, connect multiple batteries in parallel.

## 2-3. Accessory Description

Refer to the Tabos website for details (separate order specifications)

Accessory Name	Description	Purpose
Battery Low Voltage Disconnecter (BLVD)		<p>Includes inrush current limiting function, and prevents the battery from over-discharging, ensuring approximately 5% charge remains.            This safety device</p> <p>This feature prevents the high risk of fire accidents that can occur when attempting to charge a battery in a deeply discharged state.</p>
Anderson Connector Cable		<p>Connecting the battery to the charger, and between the battery and the load.</p>
Battery Parallel Connection Busbars		<p>Various busbars are standardized for different batteries, models, and installation methods.</p>
Battery level indicator		<p>A battery gauge that measures battery voltage and estimates the remaining charge based on the voltage level, displaying it as a percentage.</p> <p>While it doesn't display the exact remaining charge, it can show a general trend.</p>

### 3. Common Specifications List /

**\*Contents: Applicable Cells → Cases → Standby Power → Lifespan → Temperature → Transportation → Storage → Disposal → Wiring → Charging → BMU**

Major Category	Characteristic Value	Description
<1> <b>Cell Information, Manufacturer Information</b>	<b>Cylindrical 18650</b> , NCM (Nickel, Cobalt, Manganese) series	This product uses LG lithium-ion battery cells, and is a Korean-made product where Tabos directly designed and manufactured everything, including the BMS.
<2> <b>Battery BMU Standby Power</b>  ( /COM: Applies only to this model )	<b>BMU Device Power Consumption = 5W</b>	(Condition: When the remote ON/OFF switch is ON and the fan is not running) When not using the battery, keep the remote switch OFF.
<3> <b>Case Material</b>	Case Type: <b>C-type and D-type</b> cases → <b>Aluminum</b>	Example: CV□□□, CVCOM□□□, CVCOM, CHCOM DV□□□, DV□□□COM, DH□□□, DH□□□COM
	<b>All except C-type and D-type</b> cases → <b>Painted steel plate</b> ◇ <b>Paint color:</b> <b>Black: Past ~ 2025</b> <b>Light Gray: 2026 onwards</b>	Example: W2, W2COM, W3, W3COM, X2, X2COM, X3, X3COM, X4, X4COM VW2, VW2COM, VW3, VW3COM, VX2, VX2COM, VX3, VX3COM
<4> <b>Nominal Wh, Ah</b> Definition	(Definition)	The rated capacity (Ah) and nominal energy (Wh) marked on this product represent the ideal capacity when charging at maximum voltage while maintaining a cell temperature of 20°C and charging at 0.1C. Charging faster or at higher temperatures will reduce the charge energy.
<5> <b>Expected Lifespan</b>	LV Series: 5,000 Cycles LM Series: 4,000 Cycles LH Series: 2000 Cycles  (Estimated, varies depending on usage conditions)  (Refer to separate document 'Battery Life Data' for details)	Expected Lifespan Conditions: 1) When battery cell temperature is approximately 20°C during use. 2) Charging and discharging at a 0.2C rate. 3) When charging/discharging between 30% and 90% remaining capacity. The expected lifespan varies depending on the usage conditions. The closer the battery temperature is to room temperature, and the smaller the charging and discharging currents are relative to the battery capacity, the longer the battery life will be.  4) <u>Avoid complete discharge. The closer the remaining charge is to zero, the more rapidly the lifespan decreases.</u>
<6-1>	Charging: 0°C ~ 45°C (Charging not permitted at sub-zero temperatures)	* Note: The temperature referred to here is not the ambient temperature, but the <u>temperature of the lithium battery cell itself.</u>

Major Category	Characteristic Value	Description
<b>Charging, Discharging Temperature Conditions</b>	Discharging: -20°C to 60°C	<u>Temperature.</u> * The closer to room temperature, the better; low and high temperatures shorten lifespan.
<b>&lt;6-2&gt;</b>  <b>Expected lifespan changes by temperature</b>  / Especially during charging	Charging is not permitted at sub-zero temperatures	
	Charging at 0~20°C	(Ideal charging temperature) This is the charging temperature that maximizes lifespan.
	Charging at 30°C	Some reduction in lifespan occurs.
	Charging at 40°C	is considered high temperature and will shorten battery life.
	Charging at 50°C	The risk of battery damage increases.
<b>&lt;6-3&gt;</b>  <b>Available Energy by Temperature Change</b>  /Refers to cell surface temperature	At -20°C, the energy (Wh) during discharge at 0.2C is approximately 60%.	Energy (Wh) during 0.2C discharge is approximately 60%.
	At -10°C during discharge	Energy (Wh) at 0.2C discharge is approximately 70%.
	When discharging at 0°C	Energy (Wh) at 0.2C discharge is approximately 80%.
	When discharged at 10°C	Energy (Wh) at 0.2C discharge is approximately 90%.
	<u>When discharged at 20°C</u>	<u>Energy (Wh) at 0.2C discharge rate is approximately 1000%.</u>
	At 40°C discharge	0.2C discharge ( ) Energy (Wh) is approximately 95%.
	At 50°C discharge	Energy (Wh) at 0.2C discharge is approximately 90%.
	When applying the above data Common factors to consider when making adjustments	*At the same temperature, a higher discharge rate (i.e., higher C-rate) the available energy (Wh) decreases more significantly, and if the discharge rate is lower, the available energy decreases less.
<b>&lt;7-1&gt;</b> <b>Transportation and Storage Temperature Conditions</b>  / Ambient Temperature, Humidity	1) Transportation or Storage Conditions * Conditions: State of Charge (SOC) 30% or lower / Humidity 50% or lower 1 month: -20 to 55°C 3 months: -20 to 45°C Over 1 year: -20 to 25°C  * Note: Transportation is only possible at SOC 30% or below. / International shipping regulations Storage is possible even if SOC exceeds 30% without any issues. Storing at approximately 80% charge allows for extended storage.	
	2) Storage of fully charged products (SOC nearly 100%) / Humidity below 50% 1 month: -20 to 45°C 6 months or longer: -20 ~ 25°C	
<b>&lt;7-2&gt;</b>  <b>Transportation Method</b>	<b>(Important) Domestic and <u>International</u> Battery Transportation Methods</b> <b>(Measures to prevent fire during transport; complies with international shipping regulations)</b>  <b>&lt; For Domestic and International Transportation &gt;</b> ① Do not pack batteries together with automated equipment. ② Remove the battery from the machine it is installed in (e.g., robots).	

Major Category	Characteristic Value	Description
		<p>③ Verify the battery voltage to ensure it is charged to 30% or less.            To verify a charge level below 30%, discharge the battery to a level approximately 1V lower than its nominal voltage.            (Over-discharging is detrimental to battery life, so only discharge to a level 0 to 1V below the nominal voltage.)            Charging below 30% is extremely important. This regulation must not be violated.  <u>This is a globally recognized regulation because below 30% charge, fire is unlikely to occur from ordinary impacts.</u></p> <p>〈 For International Shipping 〉</p> <p>④ As described above, remove batteries installed in machinery, robots, etc., and ship them as standalone batteries only. Additionally, the charge level must be discharged to 30% or below. Send these to a specialized hazardous materials shipping company (forwarder) for overseas delivery.</p> <ul style="list-style-type: none"> <li>* The hazardous materials transport company will repackage the batteries according to certified standards for hazardous materials.</li> <li>* <b>Required Documents: Submit the MSDS and UN38.3 documents provided by Tabos to the shipping company.</b></li> <li>* If you do not know a battery transport company, please contact Tabos.</li> </ul> <p>* Note: International battery transport regulations: Worldwide, Air transport: IATA DGR: Worldwide, Sea transport: IMO IMDG Code: Europe, Land transport (ADR/RID/GGVSE)</p>
<p style="text-align: center;">&lt;8&gt;</p> <p style="text-align: center;"><b>Storage Method</b></p>		<p>The key consideration for long-term battery storage is preventing discharge. The battery must be disconnected from all loads.</p> <p>1) Disconnect output terminals (e.g., Main S/W OFF)            2) Disconnect internal load wiring (For COM model products, turn OFF the communication board power contact)            - Maintain the green light on the battery front panel OFF.</p> <p>→3) Store with a charge level (SOC) of at least 30%. Charge and store at nominal voltage:            (50V battery:→ nominal 51V), (25V battery:→ nominal 25.5V)</p> <p><b>4) Store with the BMU power off. Measure the voltage and recharge to nominal voltage before exceeding 1.5 years (recommended) or 2 years (maximum).</b></p>
<p style="text-align: center;">&lt;9&gt;</p> <p style="text-align: center;"><b>Disposal Method</b></p>		<p>1) Connect a load (or electronic load) to the battery and fully discharge it.            After doing this, you may send it to a lithium battery disposal company.</p> <p>2) Next, dissolve salt in water and soak the battery in this solution for at least 4 hours. This solution is called electrolyzed water.            Electrolyzed water refers to the brine used for salting cabbage during kimchi preparation in Korea.            For battery discharge purposes, an 8% to 10% saltwater solution is appropriate.            → This is water with 8 to 10 kg of salt dissolved in 100 liters (100 kg) of water. You don't have to strictly adhere to this ratio.</p> <p>3) Submerging the battery in the electrolyte water will completely discharge any remaining electrical energy in the battery.</p> <p>4) After discharging the battery, research lithium battery recycling companies and arrange for them to collect it.</p>

Major Category	Characteristic Value	Description
<p>&lt;10&gt; Terminal Tightening Torque /Power Terminal Block Screw Specifications</p>		<p>SEMS Hex Wrench Bolt: M6-15  Tightening Torque: 25 (kgf·cm)</p>
<p>&lt;11-1&gt; Battery Parallel Connection Usage</p>	<p>Batteries of the same model can be connected in parallel. That is, (+ to +, (-) to (-))</p>	<p>&lt; Conditions &gt; However, when connecting in parallel, the voltage difference between batteries must be within 0.5V, they must have the same service life, and they must have the same internal resistance. Therefore, it is standard practice to connect new batteries together; used batteries should not be connected in parallel.</p>
<p>&lt;11-2&gt; Batteries cannot be connected in series.</p>	<p>← - Absolutely no series connection.</p>	<p>Doubling voltage by connecting batteries in series is strictly prohibited. The reason is that using series connections can cause the internal voltage of the protection circuit components to exceed the allowable limit, potentially causing the BMS to fail and <b>posing risks such as fire.</b></p>
<p>&lt;12&gt; Connecting to Load</p>	<p>1) Check remaining charge before connecting the battery to the load: First, measure the battery voltage. If the voltage is near the nominal voltage, the battery is approximately 30% charged. First, connect the charger to charge the battery before use. Using the battery when the charge level is low can cause over-discharge, which significantly shortens battery life and is unsafe.</p> <p>2) To safely use the battery, insert a Battery Low Voltage Disconnect (BLVD) between the load and the battery before the BMS cuts off output due to low voltage.</p> <p>3) If the load input has a large capacitor (e.g., inverter, DC-DC converter, motor driver, etc.) a surge current of several hundred amperes may flow when the battery and load connect, causing the battery's BMS to cut off output. In such cases, reduce the surge current or add a surge current limiter.</p>	

Major Category	Characteristic Value	Description
<p data-bbox="204 488 352 696"><b>&lt;13-1&gt; Charging Method for Normal Conditions Charging Method</b></p> <p data-bbox="177 741 373 846">/Precautions When Selecting a Charger</p>		<p data-bbox="395 293 1337 322">1) Use a charger with both Constant Voltage (CV) and Constant Current (CC) functions.</p> <p data-bbox="395 367 1321 472">2) Charger voltage and current settings: * Charger charging voltage ≤ Maximum allowable charging voltage of the battery * Charger charging current ≤ Maximum allowable charging current of the battery</p> <p data-bbox="395 517 1412 734">3) Use an isolated charger. *Explanation: An isolated charger refers to a design where the primary side (AC 220V power input) and secondary side (DC battery charging output) are connected via a transformer. This converts electricity into a magnetic field and transmits it to the secondary side. This prevents accidents where AC 220V high voltage is directly applied to the battery in the event of charger failure.</p> <p data-bbox="395 779 1396 920">4) It is recommended to use a charger with an output current ripple of 5% or less. *Explanation: 0% ripple indicates pure DC, while 5% ripple means the output contains 5% AC component. Lithium battery charging is best when the current is as close to pure DC as possible.</p> <p data-bbox="395 965 1348 1025">5) Charge at a suitable current below the rated charging current. Charging at the lowest possible current extends battery life.</p>
<p data-bbox="181 1279 368 1406"><b>&lt;13-2&gt; Overdischarge Charging Method</b></p> <p data-bbox="204 1451 379 1659">/ When the battery is deeply discharged and cannot produce voltage ( )</p>		<p data-bbox="395 1055 1374 1272">1) Use a charger with a function to charge even when the battery is deeply discharged. (TABOS chargers have this capability.) During charging, disconnect any load connected to the battery and connect the charger directly to the battery in a 1:1 configuration. For batteries equipped with a BMU (Option: /COM model), also turn off the BMU power switch.</p> <p data-bbox="395 1317 1364 1377">2) There have been cases where attempting to force-charge a deeply discharged battery caused a fire.</p> <p data-bbox="395 1400 1417 1874">3) For models with 'COM' in the battery model name / models described above must be charged with the <b>charge with the Remote (Enable) switch turned OFF.</b> The reason for this is that the battery BMS has automatically cut off output due to over-discharge. and the charger detects no output voltage, charging with a micro-current pulse wave. If the communication device is ON, it consumes the charger's micro-pulse current, preventing current from reaching the battery. The reason for this is that the battery BMS has automatically cut off output due to over-discharge. and the charger detects no output voltage from the battery, so it charges using a micro-current pulse wave. If the communication device is ON, the communication device consumes the charger's micro-current pulse wave, preventing current from reaching the battery.</p>

Major Category	Characteristic Value	Description
<p align="center">&lt;14&gt;</p> <p><b>Battery Status Communication Port_BMU</b></p> <p>( /COM: Applies only to models with this port )</p>	<p>Communication Content:</p> <p>Battery Voltage, Remaining Charge, Temperature, Estimated Charge Time, Estimated Discharge Time, Error status, and other information necessary for battery usage</p>	<p>1) When multiple batteries are connected in series or parallel, the system is implemented using a master-slave configuration. The master battery aggregates the capacity and status of all batteries and ultimately transmits the battery status information.</p> <p>2) Provides pin map and protocol for the communication port connector.</p> <p>3) RS232C / RS422 / RS485 / CAN · /CAN_Open → User selectable.</p> <p><a href="#">Refer to the BMU description section for details.</a></p>
<p align="center">&lt;15&gt;</p> <p><b>Enter PN number</b></p> <p>( /COM: Applies only to models )</p>	<p>PN / Product Number</p> <p>Function to assign individual numbers to batteries.</p> <p>〈 Available starting from 2nd generation BMU. 〉</p> <p>Released from June 2025</p>	<p>Function allowing battery users to independently create a Product Number system for each battery and input it into the BMU memory. This is for managing the individual usage history of each battery. The input GUI program is provided separately by Tabos.</p>

## 4. Safety Management Function (Common Specification)

### 4-1. Description of Safety and Protection Features

#### 1). Overcurrent Prevention (Charge/Discharge Current Limitation) and Automatic Recovery

The input/output current is limited according to the set value (refer to the model-specific specification sheet) by the protection circuit (BMS) of this battery.

This function prevents the battery from outputting excessive current, ensuring safe protection.

#### 2). Output Cut-off Control During Short Circuit: Normal Operation Resumes When Short Circuit is Cleared

If a short circuit occurs between output terminals due to careless handling, the protection circuit (BMS) immediately cuts off the output.

Once the short circuit is resolved, it resumes normal operation and outputs power normally.

#### 3). Overcharge Prevention (Over Voltage Protection) and Automatic Recovery

The battery's protection circuit (BMS) monitors the voltage of each lithium-ion cell group. During charging, if any cell group exceeds the specified voltage threshold, charging stops. Charging resumes once the voltage returns to the specified level.

#### 4). Under Voltage Protection and Automatic Recovery

The battery's protection circuit (BMS) monitors the voltage of each lithium-ion cell group. If any cell group falls below the specified voltage threshold, discharge stops. Discharge resumes once the voltage returns to the specified level.

#### 5). Over Temperature Protection and Automatic Recovery

The battery cell temperature and the temperature of the control circuit components themselves are detected. If the temperature exceeds the allowable limit, charging and discharging are automatically blocked. After a certain period of time, if the temperature drops below the allowable limit, the protection automatically disengages, and the battery can be used again.

If the battery temperature rises above a certain level, the cooling system (FAN) automatically activates.

## 6). Cell Balancing Monitoring Function

It measures the voltage of each cell connected in series within the battery pack. If any cell reaches a voltage exceeding the allowable limit, charging is immediately cut off to prevent overcharging.

## 7). Battery Terminal Safety Cover



All Tabos batteries are shipped with a 'L-shaped safety cover' as shown in the photo below.

'L-shaped safety cover' as shown in the photo below.



(Structure prevents human hands from entering)

## 4-2. BMS (Battery Management Systems) Protection Action List

(Note1): All Tabos batteries have a built-in BMS.

(Note2): The safety-related values below may change without notice to improve product performance.

	Major Category	Protection Function Activation Conditions, Characteristic Values	Protection Device Disengagement/Reset Conditions, or Other Notes
①	<p><b>Overvoltage Protection (OVP)</b></p> <p>-----</p> <p>= Overcharge Protection Function</p>	<p>* 25V Battery: EOCV = 29.4V or higher</p> <p>* 50V battery: EOCV = 58.8V or higher</p> <p>* EOCV = End of Charge Voltage</p>	<p>⟨ <b>Overvoltage Protection (OVP) Release Conditions:</b> ⟩</p> <p>Discharging (AND)</p> <p>* 25V battery: Battery voltage ≤ 29.2V</p> <p>* 50V battery: Battery voltage ≤ 58.4V</p> <p>Automatically resets when conditions are met.</p> <p>* Even if the overvoltage protection (OVP) function activates, charging simply stops; discharging continues normally.</p>
<b>Charging Management</b>	<p>User Management Maximum Allowable Charging Voltage</p>	<p>* 25V battery: ~ Max. 29V</p> <p>* 50V battery: ~ Max. 58V</p>	<p>To prevent the BMS from triggering OVP protection, Charge at or below the voltage levels shown on the left.</p>
②	<p><b>Under-voltage protection (UVP)</b></p> <p>-----</p> <p>= Over-discharge Protection Function</p>	<p>* 25V Battery: EODV = 19.6V or lower</p> <p>* 50V Battery: EODV = 39.2V or below</p> <p>*EODV = End of Discharge Voltage) = Discharge Cut-off Voltage</p>	<p>⟨ <b>Low Voltage Protection (UVP) Release Conditions:</b> ⟩</p> <p>Charging is occurring (AND)</p> <p>* 25V battery: Battery voltage ≥ 21.0V</p> <p>* 50V battery: Battery voltage ≤ 42.0V</p> <p>Automatically resets when conditions are met.</p> <p>* When the Low Voltage Protection (UVP) function activates, discharge is prevented but charging continues normally.</p>
<b>Discharge Management</b>	<p>Before the battery BMS cuts off output due to UVP, The voltage at which the connection to the load must be disconnected (or the voltage at which charging should be initiated immediately)</p>	<p>It is recommended to use a device that automatically disconnects the load before the voltage drops below the specified level. Or the voltage at which charging must be initiated immediately.</p> <p>* 25V battery: Ensure voltage does not fall below Min. 23.5~24V.</p> <p>* 50V battery: Ensure voltage does not drop below Min. 47~48V.</p> <p>Following these guidelines ensures safe battery operation and extends its lifespan.</p>	<p><b>Before the battery BMS disconnects due to over-discharge,</b></p> <p><b>using a BLVD (Battery Low Voltage Disconnect) to disconnect the load first will extend battery life and prevent accidents.</b></p> <p><b>→ Available as a separate purchase with Tabos BLVD sister products.</b></p> <p><b>If the battery frequently drops to the low voltage protection threshold, the risk of fire increases due to changes in the internal chemical composition.</b></p>

	Major Category	Protection Function Activation Conditions, Characteristic Values	Protection Device Disengagement/Reset Conditions, or Other Notes
③ -1	<b>Overcurrent Protection during Charging (OCP)</b>	<p>Refer to the "Product Lineup and Individual Specifications" table for the maximum charging current value for each battery model.</p> <p>If a current exceeding the maximum current for the model flows, charging will be blocked.</p> <p>* OCP = Over Current Protection</p>	<p><b>〈Charging Overcurrent Protection (OCP) Release Conditions〉</b></p> <p>Automatically resets when the charger is disconnected from the battery</p>
③ -2	<b>Overcurrent Protection During Discharge (OCP)</b>	<p>Refer to the "Product Lineup and Individual Specifications" table for the maximum discharge current value for each battery model.</p> <p>If a current exceeding the maximum current for the model flows, discharge is blocked.</p> <p>* OCP = Over Current Protection</p>	<p><b>〈 Conditions for Releasing Overcurrent Protection (OCP) During Discharge: 〉</b></p> <p>Automatically resets when the load circuit is disconnected from the battery.</p> <p> <b>Caution:</b> Models equipped with a TABOS BMU, i.e., models with a battery status communication device (COM type) must have the communication device's enable switch (Enable S/W) turned OFF. This is because the communication device is also recognized as a load from the battery's perspective.</p>
④	<b>Short-circuit protection (SCP)</b>	<p>Automatically cuts off discharge during a short circuit to protect the battery and load. This is an electronic fuse system with an automatic reset mechanism.</p>	<p><b>〈 Short Circuit Protection (SCP) Release Conditions: 〉</b></p> <p>When the load circuit is disconnected from the battery, it automatically resets, allowing normal battery use.</p> <p> <b>Note:</b> Models equipped with a Tabos BMU, i.e., models with a battery status communication device (COM type) must have the communication device's operation switch (Enable S/W) turned OFF. This is because the communication device is also recognized as a load from the battery's perspective.</p>
⑤	<b>Cell Balancing Monitoring Function</b>	<p>If the voltage of any cell group connected in series is significantly higher or lower than the average voltage level, charging or discharging is blocked.</p>	<p>Automatically resets when the disconnection condition is resolved.</p>

	Major Category	Protection Function Activation Conditions, Characteristic Values	Protection Device Disengagement/Reset Conditions, or Other Notes
⑥	<b>Overheating Protection (OTP)</b>	<p>(Condition 1). When the battery cell surface temperature rises to 50°C or higher.            (Condition 2). When the FET (battery charge/discharge ON/OFF switching device) temperature rises above 80°C.</p> <p>Charging and discharging are automatically blocked.</p>	<p><b>&lt; Overheating Protection (OTP) Release Conditions: &gt;</b></p> <p>Overheat protection automatically disengages when temperatures drop at least 10°C below the thresholds specified in (Condition 1) and (Condition 2).</p>
⑦ -1	<p><b>Automatic Cooling System / Standard Type</b>            -----            (Product without battery communication function)</p>	<p>* Automatic ON/OFF cooling fan            Activates when internal battery temperature exceeds 40°C, and stops after a set time once the temperature drops.</p>	
⑦ -2	<p><b>Automatic Cooling System /COM Type:</b>            -----            Products with 'COM' in the battery model number            (Products equipped with a BMU. That is, products with communication functions for transmitting battery status)</p>	<p>* FAN Operation (ON) Condition            (Condition 1). When temperature reaches 40°C or higher            (Condition 2). When the charge/discharge current is 10A or higher            The fan will activate (ON) if either of the above two conditions occurs.</p> <p> Note: The communication device power must be ON for the FAN to operate.</p>	<p>* FAN OFF Conditions            (Condition A). When the temperature is 35°C or below.            (Condition B). When the charging current is 5A or less.            (Condition C). When the battery voltage drops by 0.2V from the overvoltage condition.</p> <p>The FAN stops (OFF) when all three conditions are met.</p>
⑧	<p><b>Battery Status Communication Device BMU</b>            (Battery Monitoring Unit)</p>	<p>* <b>Standby Current =</b>            Approx. 50mA / 50V battery            Approx. 100mA / 25V battery</p>	<p>When not using the battery, the BMU power switch must be turned OFF to reduce standby power consumption to zero.</p>

## 5. Battery Status Communication Device (BMU, Battery Monitoring Unit) and ON/OFF Remote (Enable) Switch

< Note: This item applies only to models with 'COM' in the battery model name. >

< Model name example: LV-50V75AH-VX3COM or LM-MOTOR-25V-70AH-X2COM >

### 5-1. BMU Hardware Description

#### 5-1-1. BMU Photos and Manual

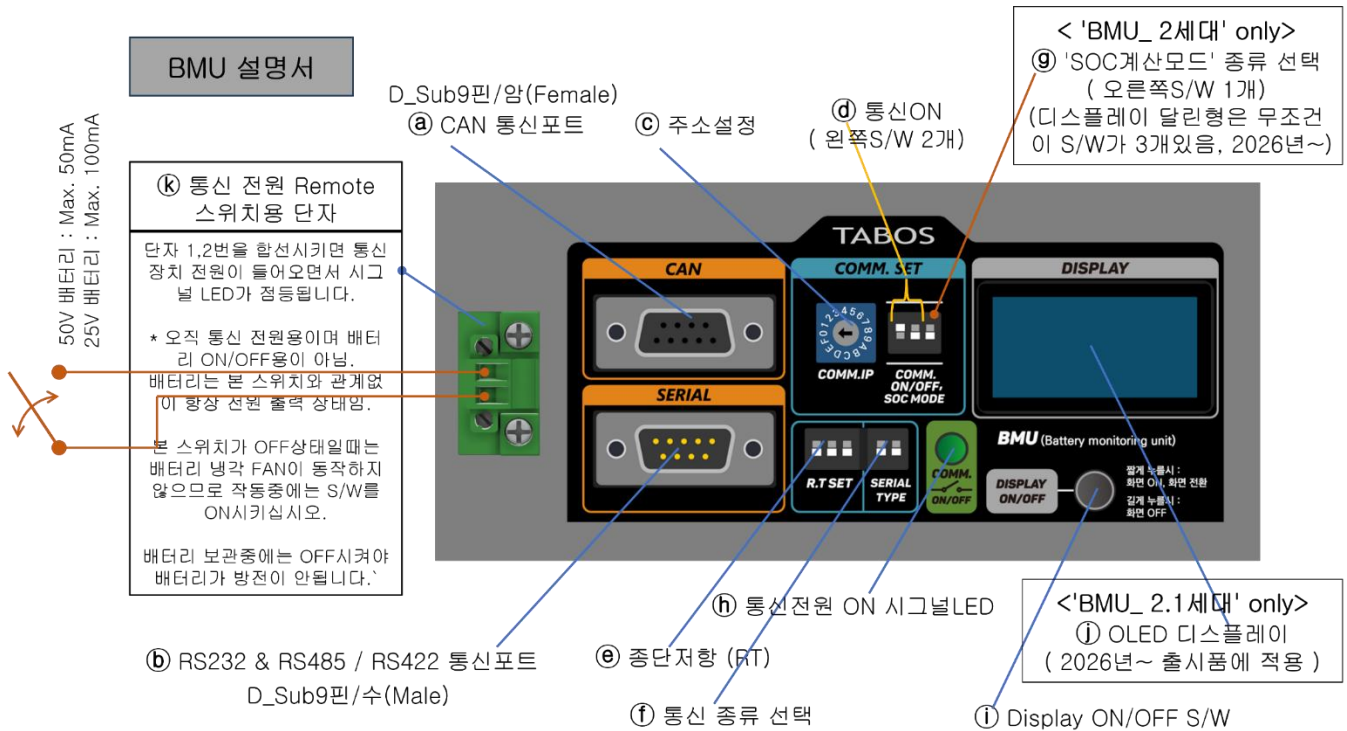

## 5-1-2. The ⑧ Communication Power Remote Switch does not turn the battery power ON/OFF.

**It only turns the battery status communication device ON/OFF.**

**When this switch is off, the communication device turns off, but the battery main power remains on.**

**The battery main power is constantly output, similar to a car lead-acid battery.**

Shorting pins 1 and 2 of the green terminal supplies power to the communication device (BMU) and illuminates the LED.

**, Detachable Screw-Type Plug, Pluggable Model: PHOENIX / Order No. 1777989**

\* Note: Series: MSTB 2,5/2-STF-5,08 ), (2P Plug, 5.08mm Pitch)

\* Caution: This screw-type detachable plug is delivered with the mating connector already attached.

You do not need to prepare a mating connector.

◇ **Pluggable Screw-Type Plug, Model: PHOENIX / Order Number 1777989**



### 5-1-3. Differences by BMU Generation (Production Year)

#### ◆ BMU\_1st Generation and BMU\_2nd Generation Compatibility:

Even if you remove a battery equipped with the previously used BMU\_1st Generation and replace it with a battery equipped with BMU\_2nd Generation, it is fully compatible without any changes to the communication protocol or communication lines.

However, the following additional features and data provided exclusively by BMU\_2nd Generation cannot be utilized.

#### ◇ BMU\_2nd Generation (Including BMU\_2.1 Generation) Features

(Applicable to all products shipped from June 2025 onwards):

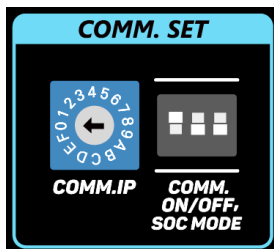

: COMM ON/OFF S/W → 3 pos

1) The following four pieces of information are additionally output in the communication data.

- \*Below: ① Charge/Discharge Cycle Information, ② Product Number (P/N) Input Function, ③ Number of Series-Connected Cells,  
④ Firmware version information

2) SOC data utilizes two methods: ㉠ Learning data based on algorithm and ㉡ Voltage-based SOC value table.

\*Users can select either of these two methods via the selection switch on the BMU.

3) The CAN\_OPEN function can be used without any additional measures.

#### ◇ BMU\_1st Generation (Shipped from past until June 2025) / Features:

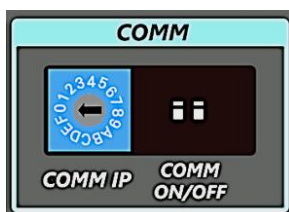

: COMM ON/OFF S/W → 2pos

1) The following 4 pieces of information are not output in the communication data.

- \*Below: ① Charge/Discharge Cycle Information, ② Product Number (P/N) Input Function, ③ Number of Series-Connected Cells,  
④ Firmware version information

2) SOC data is output as algorithm-based learning data.

\* If the battery is continuously discharged at a current of around 5A without rest during use, the SOC data accuracy decreases.

To resolve this issue, we distributed customized firmware using the <Battery Voltage-Based SOC Value Table Method> to customers who required it.

#### 5-1-4. BMU\_1st Generation, 2nd Generation Differentiation Method ;

**BMU\_2.1세대 ( 2026년 초 이후 생산 ~ )**

'@ 통신ON' 스위치가 3개짜리  
 ( 왼쪽 2개 : 통신ON설정용, 오른쪽1개는 SOC모드 설정용 )  
 ( 오른쪽 1개 : UP→배터리전압크기 기반 SOC모드, Down → 학습계산형 SOC모드)

(BMU\_2세대)와 동일하나 디스플레이가 추가된 것만 다름.

## BMU\_2세대 / ( 2025년 6월 ~ 2026년 초 )

'@ 통신ON' 스위치가 3개짜리

(왼쪽 2개:통신ON설정용, 오른쪽1개:SOC모드 설정)

(오른쪽 1개 : UP→배터리전압크기 기반 SOC모드,  
Down → 학습계산형 SOC모드)

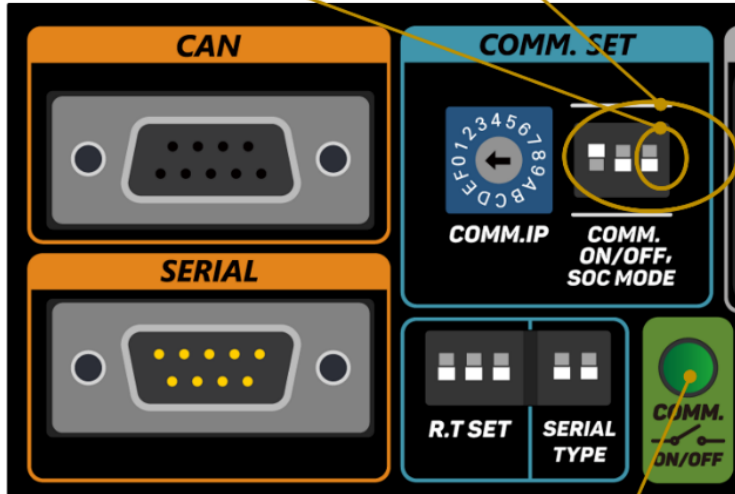

(BMU\_1세대)와 동일하지만,  
(1)시그널 LED 색상 : R,G,B / 3색으로 바뀜.  
(2)COM ON/OFF 스위치 갯수가 2개 → 3개로.  
\*내부적으로는 MCU처리능력이 큰것으로 바뀜.

## BMU\_1세대

(과거 ~ 2025년 하반기까지 생산된 모든 배터리 )

'@ 통신ON' 스위치 2개짜리

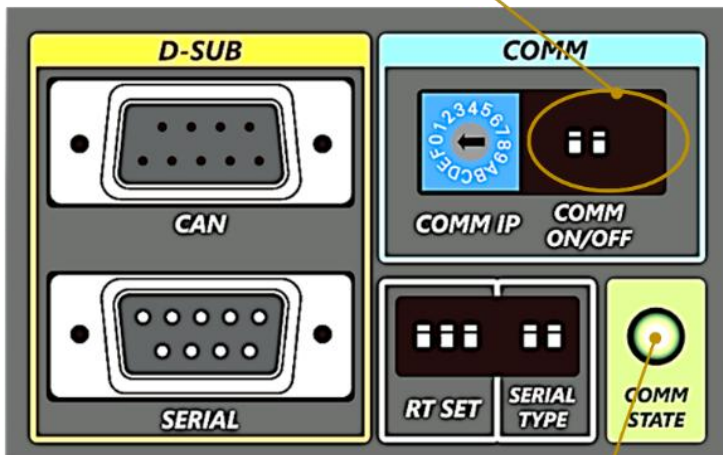

시그널 LED 색상 : 초록색 단색

### 5-1-5. Brief description of communication device functions

- ◇ Output battery status values (estimated time to complete discharge, estimated time to complete charge, battery temperature status, etc.)
- ◇ Communication types: CAN / RS485 / RS422 / RS232C

\* For other details, refer to the separate 'Communication Protocol Manual'.

### 5-1-6. SOC Data Calculation Method Selection Mode

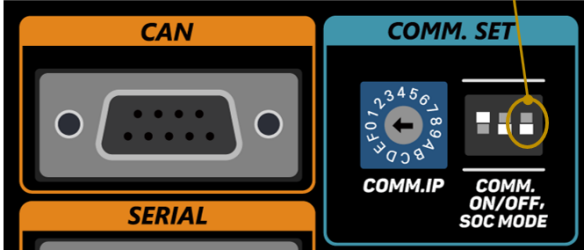
Mode Name	Mode(A)	Mode(B)
Mode Description	Learning Calculation Type	Battery Voltage-Based
Factory Default	Set to Mode (A) at factory shipment.	X
Setting Switch	<p>( SOC 모드 설정 스위치 : 오른쪽 1개 )</p> <ul style="list-style-type: none"> <li>▶ UP → Mode(B) : 배터리전압크기 기반 SOC모드</li> <li>▶ Down → Mode(A) : 학습계산형 SOC모드</li> </ul>  <p>For products released after June 2025, the select switch has three positions as shown in the photo above. Products manufactured before that date do not have an SOC mode setting switch.</p> <p>If a user of an earlier product encounters a field situation requiring Mode (B), contact Tabos to have the BMU software changed to another version.</p>	
Operating Principle	Based on data such as battery voltage, current, temperature, and internal resistance, it outputs the SOC value calculated from values learned over time.	It creates a table of estimated SOC values for each battery voltage and outputs the corresponding SOC value for each voltage value.
Advantages and Disadvantages	This is the most reliable and problem-free method unless special circumstances arise.	In situations where voltage fluctuates suddenly, the SOC value fluctuates accordingly. For example, plugging in a charger can cause the battery voltage to rise by 1-2V, and in such cases, the SOC value can fluctuate by more than 10%.

## 5-1-7. SOC Calculation Characteristics of Gauge IC and Actions to Take When Issues Occur

### A) SOC Calculation Method of Gauge IC:

- The SOC (%) value output by the BMU is calculated using the Gauge IC's own algorithm.
- The variables used in the calculation are internal resistance, voltage, current, temperature, and cell chemistry values (based on calibration).

### B) Gauge IC Characteristics Related to Battery Charge/Discharge Current.

- SOC increase is conservatively calculated in proportion to the charging current magnitude.
- During discharge, SOC decrease is conservatively calculated in proportion to the current magnitude.
- ::: It has a function to recalculate automatically after charging (3 minutes or more) if discharge conditions are met,  
and you can observe the SOC value being recalculated (based on the calibration values) :::

### C) Causes and countermeasures for SOC exceeding the error range.

#### 〈 Cause 〉

- Ah decreases due to protection actions shutting down some modules inside the pack. - Requires separate inspection.
- Malfunction of the gauge IC (calculation halt) due to environmental noise interference, among other factors.

#### 〈 Field Actionable Solutions 〉

- Reset the board power using the green contact (BMU power switch) (current must be at minimum state).
- After charging for at least 3 minutes, maintain a discharge standby state below 5A for about 2 minutes to trigger automatic recalculation.
- If the above two measures are ineffective, separate consultation and inspection are required.



< Data 1/2. Battery Status Output Data >

No.	Data Name	Unit	Scale	Range	Data Content, Description	When using parallel battery connections Data Collection Method
1	<b>Voltage</b>	V	0.01	0 ~ 655.35		Displayed as data for each battery in parallel connection. (However, since they are connected in parallel, the voltage difference will be within 0.5V.)
2	<b>Current</b>	A	0.01	(-) 327.68 ~ (+) 327.67 (-): Discharge, (+): Charge <b>Variable declaration → signed</b>		Display data for each battery in parallel connection. If the difference in data values between batteries exceed 15% <u>at or above the nominal voltage</u> , inspection is required.
3	<b>SOC (State of Charge)</b>  (State of Charge)	%	1	0 ~ 100		Display data for each battery in parallel connection. If the data value difference between batteries exceeds 15%, inspection is required.
4	<b>Battery Status Information</b> (Next page ☞ Details)			If no data is displayed, the battery is in normal condition. Data is only output when a problem occurs.	<b>*Types of Abnormal Status Data (Details):</b> Overvoltage, Undervoltage, Overcurrent, High Temperature, Low Temperature, BMU Communication Error	Data is displayed for each battery in parallel connection. If error information appears on any one battery, inspection is required.
5	<b>Charge completion time</b>	min	1	0 ~ 65535	Calculation formula: Charge completion time (H) = Ah to be charged / Charging current A, This value is corrected by applying a weighted average.	
6	<b>Discharge completion time</b>	min	1	0 ~ 65535	Calculation formula: Discharge completion time (H) = Remaining Ah / Discharge Current A,	

No.	Data Name	Unit	Scale	Range	Data Content, Description	When using parallel battery connections Data Collection Method
					This value is corrected by applying a weighted average.	
7	Temperature	℃	0.1	(-) 3276.8 ~ (+) 3276.7 (-): below zero, (+): above zero  Variable declaration → signed		Display data for each battery in parallel connection. If the data value difference between batteries exceeds 10℃, inspection is required.
8	SOH (State of Health)  (State of Health)	%	1	0 ~ 100 (Reference Values): New: 95 ~100% Used, Aged: 80% or below	If the value is 80% or below, have it inspected or dispose of it. This phenomenon may also occur when some modules within the battery pack, connected in parallel, have their charging or discharging functions restricted by the BMS.	Display data for each battery in parallel connection. If the difference in data values between batteries exceeds exceed 15%, inspection is required.
9	Residual Capacity	Ah	0.01	0 ~ 655.35		Displayed as data for each battery in parallel connection. If the difference in data values between batteries exceed 15% <u>at or above the nominal voltage</u> , inspection is required.
10	Remaining Energy	Wh	0.1	0 ~ 6553.5		Displayed as data for each battery in parallel connection. If the difference in data values between batteries exceed 15% <u>at or above the nominal voltage</u> , inspection is required.

No.	Data Name	Unit	Scale	Range	Data Content, Description	When using parallel battery connections Data Collection Method
11 (25.06 Added)	<b>Charge-discharge cycle</b> (Full Cycle) < See Note 2 >	Cycles	1	<Applicable to BMU_2nd Generation> (Produced from 25.06~)	If the BMU power switch is turned OFF and the battery is used, this data will not accumulate.	Display data for each battery in parallel connection. If the data value difference between batteries exceeds 10%, inspection is required.
12 (25.06 Added)	<b>Part Number (P/N) Input Function</b> ( Product Number )			<Applicable to BMU 2nd Generation> (Produced from 25.06~)	This data is used by the user to directly input the P/N number via a GUI using separate software provided by Tabos.	It displays the data for each battery in parallel connection.
13 (25.06 Added)	<b>Number of Cells in Series</b> ( 7 or 14 )			< BMU_Applied to 2nd Generation > (Production from 25.06~)	Number of lithium-ion cells connected in series within the battery pack: 25V (7S) or 50V (14S). This data is not managed by the battery user.	Display data for each battery cell in parallel connection.
14 (25.06 Added)	<b>Firmware Version</b>			<Applied to BMU 2nd Generation> (Produced from 25.06~)	Firmware rev. display.	Displays data for each battery in parallel connection.

**Note1:** The **added data** (fields **11 to 14**) applies to all types of Tabos batteries (BMU\_2nd generation batteries) shipped starting **June 15, 2025**.

For all Tabos batteries shipped prior to this date, updating the BMU (Battery Monitoring Unit) firmware provided by Tabos to the latest version will enable this data to be used. This firmware can be downloaded from the Tabos website and installed directly on the battery by the user.

**Note2: Definition of 'Full Cycle' in :**

Charge/Discharge Cycle (Times) Definition: Can be classified as full cycles and partial cycles ---> The BMU data values here use the full cycle concept.

A) Starting from full charge (SOC 100%), use until SOC 50%, then recharge to full charge --> This counts as 0.5 full cycles.

Performing this charge/discharge twice --> 1 full cycle, or 2 partial cycles

B) Starting from full charge (SOC 100%), use until SOC 70%, then recharge to SOC 100% --> This counts as 0.3 full cycles.

Performing this charge-discharge cycle 3.3 times results in: 0.3 cycles x 3.3 = 1 full cycle, or 3.3 partial cycles

〈 Data 2/2. Battery Status Information / Detailed data from "4. Battery Status Information" in the previous table 〉

Bit	Description	Bit	Cause	Battery Operating Status	User Action
0	<b>Battery Overvoltage</b>	8	25V Battery: Exceeding 29.4V 50V Battery: Exceeding 58.8V	Discharge possible, charging not possible	If charging, stop charging immediately and discharge quickly to lower the voltage.
1	<b>Battery Low Voltage</b>	9	25V battery: Below 21V 50V battery: Below 42V	Cannot discharge, but charging is possible	Must be charged immediately.
2	<b>Excessive charging current</b>	10		Discharging is possible, but charging current must be reduced immediately.	The charging current must be reduced immediately.
3	<b>Excessive discharge current</b>	11		Charging is possible, but discharge current must be reduced immediately.	The discharge current must be reduced immediately.
4	<b>High temperature</b>	12	Cell surface temperature 50 degrees Celsius or higher conditions		Use a further reduced charge/discharge current, or ensure the battery is cooled properly. If the fan does not operate, contact Tabos.
5	<b>Low Temperature</b>	13	Below 0°C conditions	Although not dangerous due to the low temperature, this signal is output because battery operation is not optimal.	At temperatures below 0°C, charging may cause voltage to rise, preventing proper charging. and in conditions between -20°C and 0°C, the voltage may drop during discharge, potentially limiting battery discharge.
6	<b>BMU Error</b>	14	When an internal signal transmission error occurs within the circuit device.	The battery itself operates normally. However, the function to transmit the battery status externally does not work.	Primary Action: Turn the BMU power switch OFF and then ON. Secondary Action: If the primary action does not work, contact Tabos.

**[ Note 1 ]**

The communication protocol may change due to circumstances at our company. Please verify the latest version.

[Download the protocol specification document from our website for use.](#)

**[ Note 2 ]****◇ SOC (State Of Charge, Battery Level):**

1) Unit: 0~100%, fully charged at 100%, fully discharged at 0%

2) Battery Level (SOC) Measurement Method: Battery level is not calculated solely based on battery voltage. SOC data is generated using a statistical method incorporating multiple pieces of information, including internal battery resistance, battery voltage, and the cumulative charge or discharge current flowing through the battery.

Therefore, even if the battery voltage fluctuates rapidly during charging or discharging, the SOC value changes gradually rather than abruptly.

2) Fully Charged State: Typically, when fully charged, this data value may not reach 99~100%. To reach 100%, charging must be done very slowly, and the battery must be sufficiently charged up to the full charge voltage. Generally, if the value shows 95% or higher, it can be considered fully charged.

3) Discharged State: Typically, when discharged, this data value may not reach 0%.

To reach 100%, charging must be done very slowly, and the battery must be sufficiently charged to the full charge voltage. Generally, if the value shows 95% or higher, it can be considered fully charged.

\*Special Note: Accurate calculations require the battery to reach full charge occasionally.

However, for battery safety management, it is generally used without charging to full capacity, which may slightly reduce data precision.

**[ Note 3 ]****◇ SOH (State Of Health, Battery Health):**

1) Unit: 0~100%

The closer to 100%, the closer the battery is to its normal capacity; the closer to 0%, the more degraded the battery function is.

\*Special Note: Accurate calculations require the battery to occasionally reach full charge.

However, for battery safety management, it's common practice not to charge to full capacity, which can slightly reduce data accuracy.

\*Special Note 2: To illustrate the usefulness of SOH values, consider the following example.

A battery has been in use for 7 years and is functioning normally. At that point, the SOH value may show 80~90% or higher.

Using this value alone makes it ambiguous to determine whether the battery has reached the end of its life.

However, continued use may lead to sudden battery failure (often due to prolonged use causing natural cell imbalance, rendering it unusable).

Rather than gradually declining over the service life, the SOH value often remains above 80% and functions normally until the battery suddenly becomes unusable.

There isn't a lot of empirical statistical data available yet.  
Therefore, it is advisable to treat this SOH value as a reference value.

## 6. Product Drawings and Photos

**\* Refer to the attached drawings for each model name. The last number in the model name indicates the mechanical case type number.**

Example 1: LM-MOTOR-50V-35AH-X2COM → . See the 'X2COM' mechanical drawing.

Example 2: LV-50V75AH-VX3COM/V → For the mechanical drawing, see 'VX3COM/V'.

**\* Drawings can be downloaded from the website. / dwg, pdf, 3D (stp, igs)**

**\* The drawings below are simplified summaries for reference only.**

[ X2, X4 type cases ].

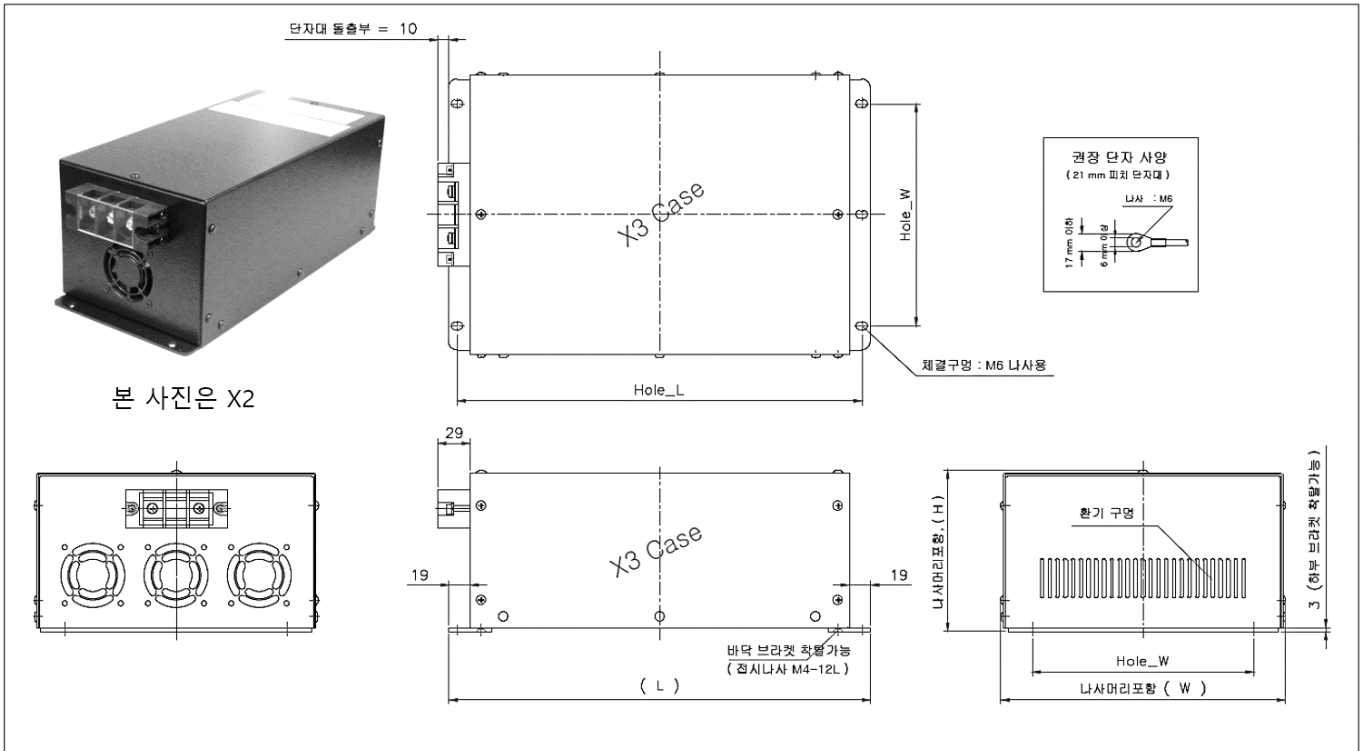

Unit: mm, For detailed drawings, please download the latest version of the drawings from the homepage.

Case names	W	H	L	Hole_W	Hole_L	Remarks
X2	174	145	380	120	365	
X4	306	145	380	250	365	

Unit: mm

\* See attached drawing for homepage

[ X2COM, X4COM cases ].

(BMS communication device equipped)

For detailed drawings, download the latest version of the drawings from the homepage.

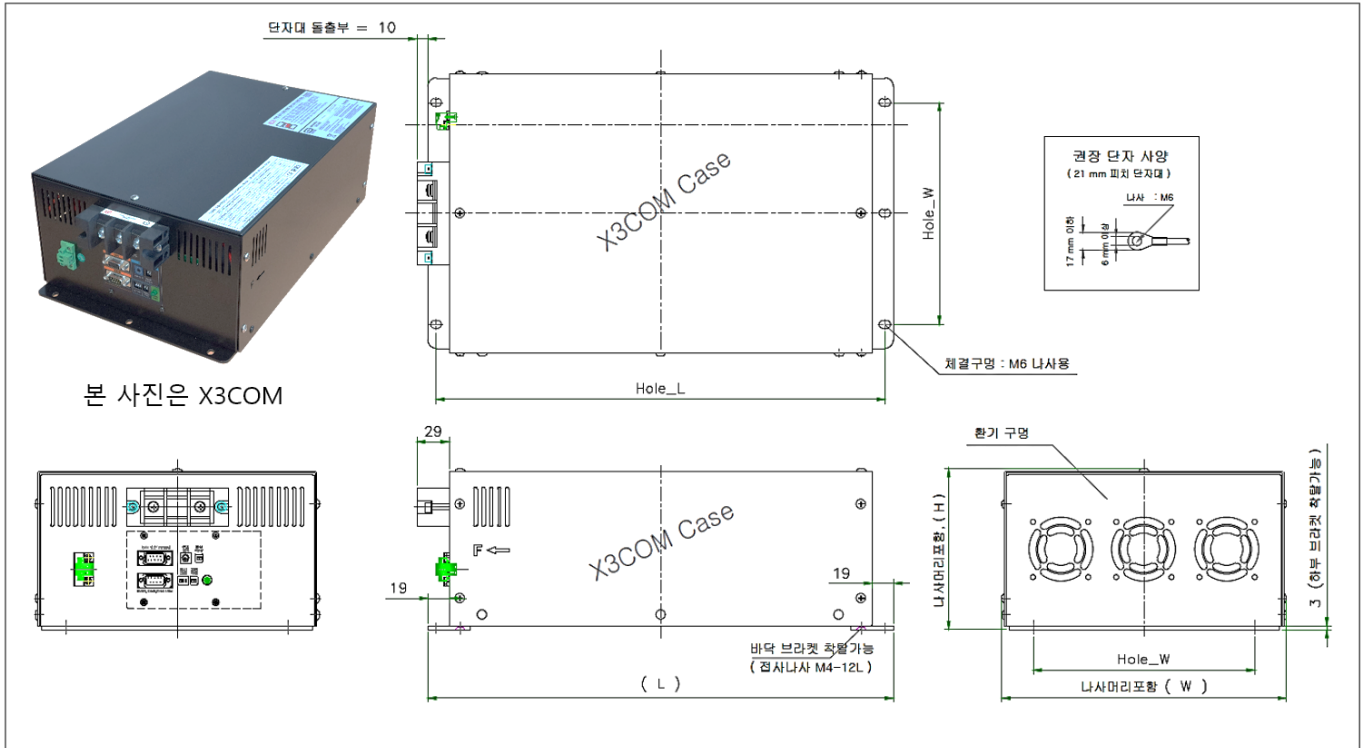

Unit: mm, For detailed drawings, please download the latest version of the drawings from the homepage.  
 Cycle: In the case of COM model, the communication port operation switch is changed to the terminal block for Remote.

Case names	W	H	L	Hole_W	Hole_L	Remarks
X2COM	174	145	420	120	405	
X4COM	306	145	420	250	405	

Unit: mm

\* See attached drawing for homepage



< Battery Installation Direction / X4, X4COM Case

**배터리 설치방향 ( Yes or No )**

별(☆) 숫자가 많으면 내진동성이 큰 것임.

**제한적OK (☆☆)**  
(작은 진동은 허용)

**제한적OK (☆☆)**  
(가장 이상적 상태)

**No !**  
(사용불가)

**제한적OK (☆)**  
(진동있으면 사용 어려움)

1

2

3

4

5

6

**X4 / X4COM**

2021.08월 이전 출고제품 : 설치 불가  
X4 및 X4COEM --> 폭(W) 306.5mm 인 제품  
이런 방향 ( ⑤⑥ ) 설치는 불가함.

2021년 08월 이후 출고분에 대해서는  
주행로봇(AMR,AGV) 으로서 실내용(Indoor,공장용)일  
경우 진동이 미미하므로 사용 가능함.

[ W2, W2COM, W3, W3COM case ]

(Standard and with BMS communicator)

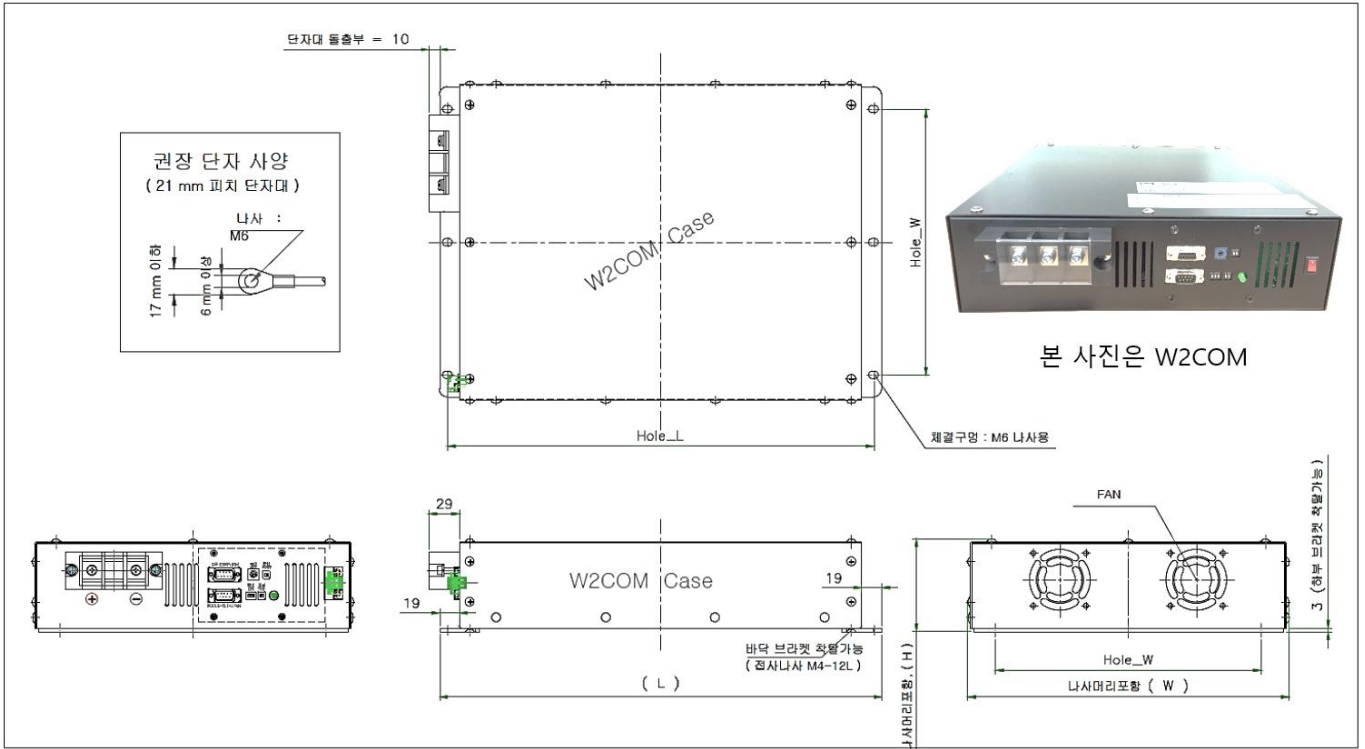

Unit: mm, For detailed drawings, please download the latest version of the drawings from the homepage.  
 Cycle: In the case of COM model, the communication port operation switch is **changed** to the terminal block for Remote.

If it is not a COM model, there is no communication port on the drawing.

Case names	W	L	Hole_W	Hole_L	Remarks
W2	305	380	252	365	
W2COM	305	420	252	405	
W3	446	380	390	365	
W3COM	446	420	390	405	

Unit: mm

\* See attached drawing for homepage

< Battery Installation Direction / W2, W2COM Case

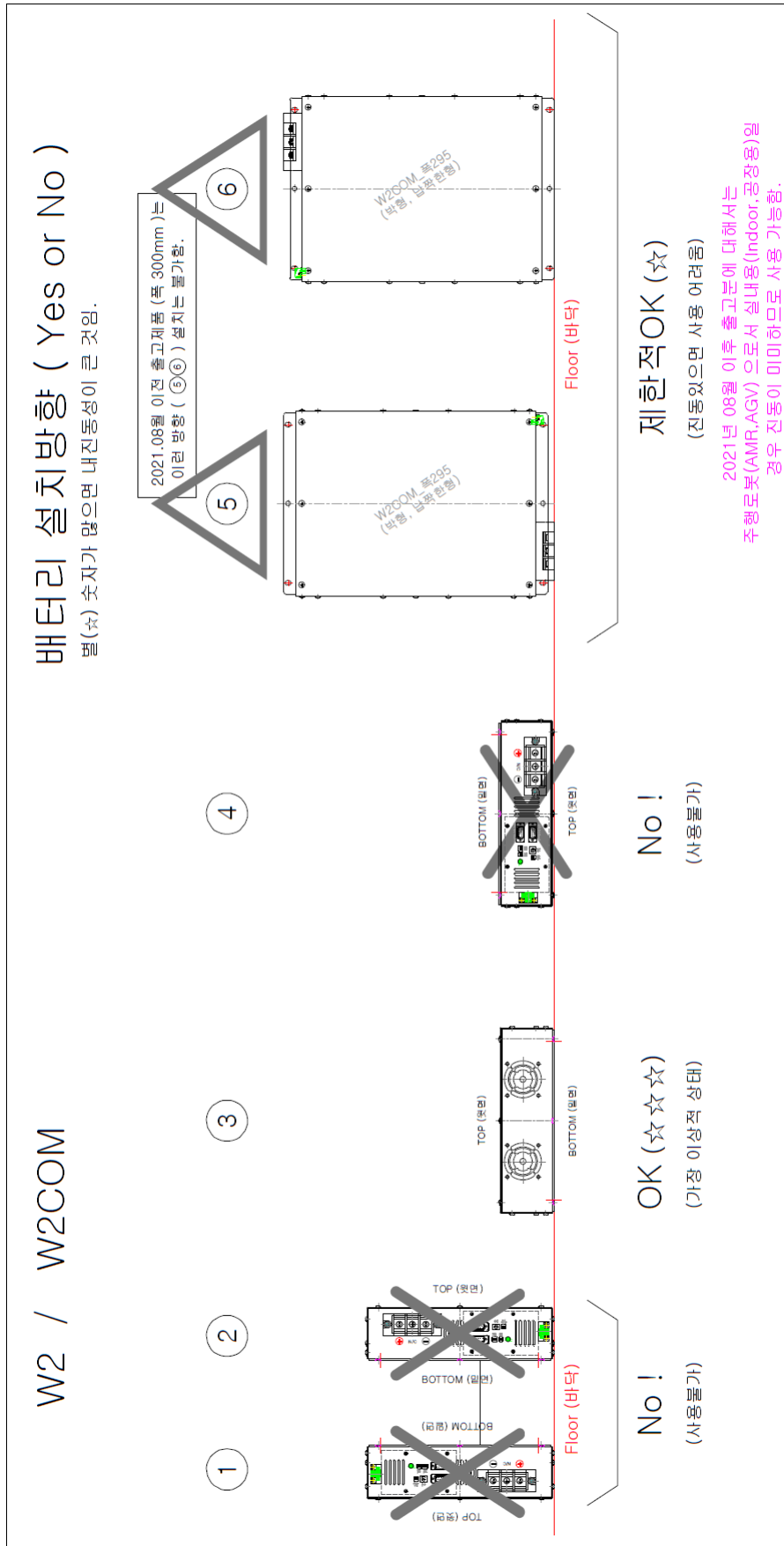

< Battery Installation Direction / W3, W3COM Case

**W3 / W3COM**

**배터리 설치방향 ( Yes or No )**  
별(☆) 숫자가 많으면 내진동성이 큰 것임.

2021.08월 이전 출고제품 (폭 436mm)는  
이런 방향 (⑤⑥) 설치는 불가함.

①

TOP (앞면)  
BOTTOM (뒷면)

②

TOP (앞면)  
BOTTOM (뒷면)

③

TOP (앞면)  
BOTTOM (뒷면)

④

TOP (앞면)  
BOTTOM (뒷면)

⑤

W3COM 폭436  
(폭형, 내진동형)

⑥

W3COM 폭436  
(폭형, 내진동형)

**No !**  
(사용불가)

**OK (☆☆☆☆)**  
(가장 이상적 상태)

**No !**  
(사용불가)

**제한적OK (☆☆)**  
(진동있으면 사용 어려움)

2021년 08월 이후 출고분에 대해서는  
주행로봇(AMR,AGV) 으로서 실내용(Indoor,공장용)일  
경우 진동이 미미하므로 사용 가능함.

**Floor (바닥)**

**제한적OK (☆☆)**  
(진동있으면 사용 어려움)