

(1/2) Specification Sheet

3500 Watt lithium battery charger

〈 Industrial / Indoor / Stationary 〉

Applications: Automation systems (FA) / Industrial electric vehicles / Autonomous robots (AGV / AMR)

Applicable batteries: Any type of battery that fits the charging voltage range, including lithium (ion, polymer, iron phosphate) batteries

* See separate document for communication protocol (RS485)

☞ [2 of 2, Communication protocol] Charger TC-3500W Series, RS485

Model: TC-3500W-50V60A

⚠ It is set to 57.0V, 40A at the factory.

For 50V battery : Charging voltage 52V~Max. 58V, charging current 10A~60A / Charging current (5A unit), voltage (0.5V unit) adjustable type

Input power: Single-phase AC200V ~240V/18A at 220VAC

We do not provide AC input wires, you will need to provide your own.

Do not use a pig-nose outlet plug due to excessive AC input current (up to 18A) for this device.



CE CB FC
IEC60335-1,2



Control Panel: Options Instruments

Charger : Export HS Code : 8504.40.30 / Control Panel : Export HS Code: 8537.10.9000

2D drawings (DWG), 3D drawings (STP, IGS), communication protocols (protocol_ RS485), specifications, user manuals (user manuals), etc. You can download it from the Tabos homepage.

Designed and Made by TABOS in Korea

Copyright Protection.

This user manual and product are protected by copyright law.

Part or all of this user manual and product may not be copied, reproduced, translated, or converted to electronic or machine-readable form without the prior written consent of TABOS Inc.

This user manual and product may contain typographical or technical errors, and the contents are subject to change without prior notice.

Copyright Protection.

Copyright© 2021 ,TABOS Inc. All Rights Reserved.

Index

1. product mix and customer ready items
2. Important notes
3. list of specifications
4. drawings
- 5. safety management function / product features / charging process description**
6. how to use

7. settings and external control methods
 - 7-1. External Control Using DIO
 - 7-2. Control by connecting to the control panel (option product) using DIO
 - 7-3. External control via RS485 communication / Using D-SUB 9Pin connector

- 8. error and status messages**

15. Efficient use of chargers and charging characteristics





20. Add an external control method
 - 20-1. Blue Tooth Wireless Communication
 - 20-2. Ethernet (LAN) Communication



21. Charger Control Panel (Optional) Specifications/Drawings and Usage





◆ Special mention: CE, CB certification requirements :



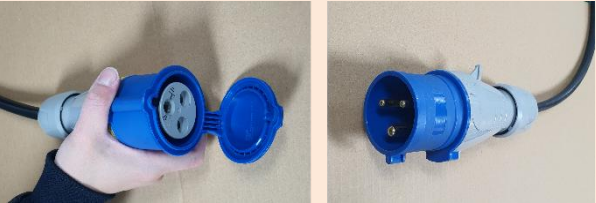

- 1) User Interface / Communication port (D_SUB9 pin, DIO port) operation test is excluded,
- 2) Excludes User Interface / Communication port operation test for parallelization,
- 3) Excluding User Interface / Thermal S/W input terminal operation test

1. product mix and customer ready items

Default /Optional	Item	Photos	Name	Specs	Remarks, uses
Products for sale (default)	Charger body		TC-3500W-50V60A		
Products for sale (default)	Output wire (charging wire)		m6-25sq-1m-rb-m6	(1) Wire KIV 25sqmm (Red (+) and Black (-)) (2) Wire length of 1 meter (3) Double-ended ring terminal (M6) Crimp terminals: Jor / JOR25-6 and	
Products for sale (Optional)	Anderson connector wires		SB120A-Gray-M6-800L	Connector: Anderson SB120A, Gray Ring terminal: opposite the connector, ring terminal for M6 Wires: KIV, 25 mm ² , red+black, Length: 800 mm (excluding connector body dimensions)	Sold separately (For safety management/conv enience)
Products for sale (Optional)	Charger Control Panel		TWC-TX-STA-PNL	1) Describe the function of the emergency lights and switches: (from left in photo) *Charge status indicator → Standby (Y), Charging (G), Error (R) *Emergency switch *Charge ON/OFF switch (rotary switch) *Error clear switch (pushbutton) ----- 2) Other features: * Ability to drive additional external FANs while charging	Sold separately (For safety management/conv enience) This is connected to the DIO port of the charger body. There is only one DIO port on the charger. Therefore, when using this control panel, use RS485

Default /Optional	Item	Photos	Name	Specs	Remarks, uses
				* Ability to detect whether the robot (AGV, AMR) has arrived at the charging station and access the proximity switch.	communication to communicate with the charger body.
Products for sale (Optional)	DIO communication lines		trx-dio-cable-2.0m	(Note: Even without this DIO, if you set it to auto mode, it will automatically detect the battery connection and charge automatically). ----- *Connector housing : *Mollex 430250800  *Wire : UL2464, 8Core shielded cable *Wire length is 2 meters, *Pin number 1,2,3,4,5,6,7,8 / *Color: (in pin order) Black, Red, Orange, Yellow, Blue, Green, Brown, White	Sold separately (Prepare as needed) Only required when communicating with DIO
< Prepared by the customer below >					
(Prepared by customer) ----- Not provided by Tabos.	AC input wires		< Note > (Don't use pig-nose formatting) *Reason : Exceeded pig nose usage with input current 18A *Bite directly into the blocker.	(1) Wire VCTF (or VCT) 3 Core (L, N, E) , 4 mm2 (2) Connection ring terminal: Use the ring terminal for M4, Crimping Terminal Recommendation : JOR4-4 / JOR5-4 (3) Recommended wire stripping length= 50mm (4) AC220V : L, N, E → 3-wire	Essential basic preparation

Default /Optional	Item	Photos	Name	Specs	Remarks, uses
(Prepared by customer)	European industrial socket plug (Legrand plug/socket)			Type : Socket (female) : 555214 Type : Plug (Number) : 555234 ----- European industrial sockets/plugs AC250V 32A ----- < Note > Something handy to put between the charger and the breaker.	(Prepare as needed) (handy to have)
(Prepared by customer)	Wires for grounding			(1) Wire KIV, abstract, 1 Core, 4 mm2 (2) Connection ring terminal: Use ring terminal for M4 Crimping Terminal Recommendation : JOR4-4 / JOR5-4	Essential basic preparation
(Prepared by customer)	D-SU9-pin connector cable for communications		D-SUB 9-pin cable Supin (Male)	(Note: Even without this DIO, if you set it to auto mode, it will automatically detect the battery connection and charge automatically). ----- Compared to communicating using DIO 1) You can command the charge voltage and charge current size to change ON Line. 2) You can get detailed data about the error.	(Prepare as needed) Only required when communicating over RS485
(Prepared by customer)	Bimetallic temperature switch		On the open market <Search term: Protherm A-contact temperature switch 60 degrees> Search for the product.	① Permissible current: 100mA or more required ② N.O. (Normally Open) Type = A contact ③ Recommended operating temperature: 60°C ④ Operating temperature tolerance: ±5°C or less *Reference: Protherm temperature switch	Wiring multiple temperature switches in parallel where heat can be generated during charging (AMR/AGV battery charging contactors, etc.).

Default /Optional	Item	Photos	Name	Specs	Remarks, uses
(Prepared by customer)	Parallelism Communication cables RJ45		rj45 (8p8c / cat6) , Total Length = 200mm Fit , CAT6 and higher numbers are fine. (e.g. CAT7, CAT8, CAT9)	RJ45 plugs on both sides, Quantity required : 2Parallel operation → 1 3Parallel operation → 2 4Parallel operation → 3 	(Prepare as needed) If you want to run multiple chargers in parallel to increase the output Required only if
(Prepared by customer)	RS485 to Blue Tooth Wireless Communication Converters ----- (Serial to Bluetooth Converter)		Connecting to this charger: Name1 : RCPORT-TD450 / (Male / Male) ----- Connect to Host Name2 : RCPORT-TD420 / (USB plug)	■ Plug this directly into the Tabos charger D-SUB 9-pin connector (female, female). The pin map matches. 5V power is also supplied directly from the D-SUB 9-pin. Manufacturing, sales: Chipsen / chipsen.com I put the considerations behind the documentation I created in Tabos.	(Prepare as needed) Monitor / control the charger via Bluetooth wireless communication When you use
(Prepared by customer)	RS485 to Ethernet (LAN) communication Converters ----- (Serial to Ethernet Converter)		Type: sLAN/all	Caution: You cannot plug this directly into the Tabos charger D-SUB 9-pin connector (Female) directly, the pinmaps do not match. You will need to make your own pin-matching wire harness and insert it between the Ethernet converter and the D-SUB 9-pin connector of the Tabos charger. Manufacturing, sales: System Base / sysbas.com Special considerations for applying to the Tabos charger have been included after the documentation created by Tabos.	(Prepare as needed) Monitor / control the charger with Ethernet (LAN) communication When you use

2. Important Cautions (Designers & Users)

⚠ Charger Enable Switch and bimetallic thermoswitch input terminals:

1) Enable Switch → The unit will only operate when this connector is shorted (Closed , Shorted).

If the LCD window is off even though the charger's main switch is turned on, click the
This is because this 'enable switch' is open.

Before use, make sure that the electrodes of this connector are shorted to each other. They must be shorted to work.

Normal Closed.

(The 'enable switch' is short-circuited with jumper wires at the factory by Tabos.)

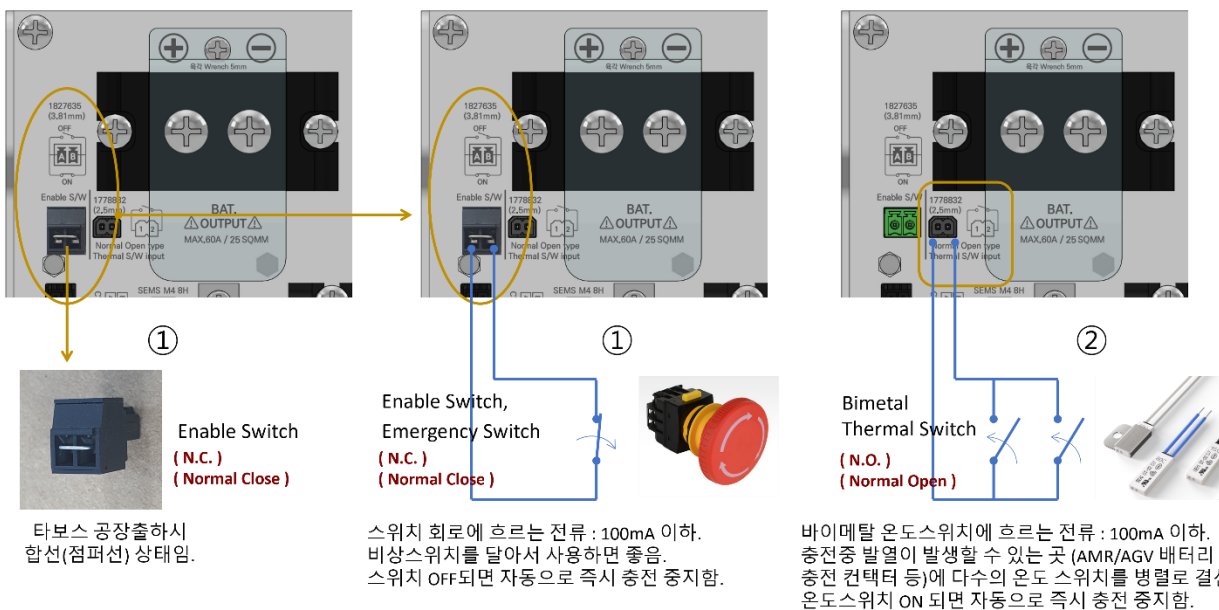

In 'Enable Switch (N.C. Type)', you can paste an emergency switch to make it easier to respond in case of an emergency.

What is Emergency? → It is useful in case of fire or smoke in the battery and related circuitry while charging.

If you open (off) this 'Enable Switch' while charging (i.e. press the emergency switch), it will stop charging immediately.

Even if this behavior occurs frequently, this charger will not be overwhelmed.

When the Enable Switch is in the Open (Off) state, the LCD window displays the message below.

Enable S/W off Status.
Check Out Enable S/W

2) Bimetallic thermoswitch → When this connector is in the On (Short) state, the charger will immediately stop working.

⚠ The charger has two modes of operation and is set to "Auto" at the Tabos factory.

A) Automatic Mode

When a battery is connected, the charger automatically detects its voltage and charges it if it's okay. Shut off the output of the charger when the battery is disconnected from the charger. This means that the output of the charger will not be energized unless the battery is plugged in. (Safety Management Dimension)

B) Manual Mode

You can manually turn the charge on/off using the buttons on the LCD monitor, or you can use the Use the communication cable to control the charge (via RS485 or DIO command).

Again, just like in automatic mode, the

It only outputs electricity when the battery is plugged into the charger.

This means that the output of the charger will not be energized unless the battery is plugged in. (Safety Management Dimension)

You can change the mode via the 'Auto/Manual' button pictured below, and you can also use the Once changed, the mode is remembered even when powered off.



MAN / AUTO information is also displayed on the LCD monitor.

In manual mode, you can press the 'CHG ON/OFF' button under the LCD monitor or give a charge command via communication (RS485 or DIO).

 **Battery charging Do not turn AC input power on/off for the purpose of turning on/off the charging behavior.**

(If used in this way, the charger's firmware (S/W) may malfunction in some cases, resulting in impaired operation.)

This charger detects the battery connection status (battery present or absent) and automatically controls charging. It is safe because the output does not go out when the battery is not connected. It works automatically even if the AC input power is not turned on or off.

For automated guided vehicle (AGV) charging stations, always keep the AC input power ON and apply the charging electrodes to the AGV upon arrival at the charging station to automatically initiate charging.

 **Charging a lithium battery with an undervoltage cutoff would not charge properly.**

If the lithium battery is under-voltage cut off, and the standby power of the load connected to the charger (which is also connected to the battery) absorbs the charger's startup current, the battery may not be able to charge and remain in standby.

This situation can occur in automated guided vehicles (AGVs), driving robots, etc.

The charger has a failsafe that prevents the output from going out when no battery is connected.

Lithium batteries have a built-in BMS/PCM device that will shut down the output if it goes into a low voltage state. The charger will detect if the battery is connected by the micro output, and if the battery is in a low voltage cutoff state, it will not detect the battery voltage, so it will not do a full charge and will only send out micro power.

If the various electrical devices connected to the load are left on, the trace power from the charger will be consumed by the load's standby power, preventing it from charging over time.

If this happens, you should turn off the switch (breaker, etc.) that is connected to the load so that the charger's small output current does not drain the load's standby power. After doing so, you can turn on the switch that is connected to the load when the charger starts the main charge.

 **The use of wires that are too thin for the current will cause the wires and connectors to deteriorate in the long run, resulting in fires.**

For charging wires, you should also use the proper wire thickness to reduce the amount of voltage drop to ensure that charging is on target.

The wire thickness is determined by the current draw.

◇ AC input power line :

Formula for calculating the allowable current per wire gauge for AC input wires: $5A/\text{mm}^2$ (SQMM) minimum.

In a normal temperature environment, the allowable current per 1 mm² (square millimeter) of wire can be calculated as 5 amps. If the ambient temperature is above 40 degrees Celsius, you may also need to use thicker wire than the above calculation, but this is for safety reasons, such as the wire heating up.

If the AC input max current is 20A --> minimum $20/5=$ Select standard 4 mm²wire.

◇ DC battery charging wire :

Formula for calculating the allowable current per wire thickness of the charging line: Minimum $3A/mm^2$ (SQMM). (Condition: When the length of the charging line is 2 meters or less.)

This is the specification recommended by TABOS. Thin charging wires cause a voltage drop. A voltage drop of just 0.5 V will cause the battery to charge less. This is to reduce the amount of voltage drop across the wires when charging to ensure that the charging is on target.

If the length of the charging wire is longer than 2-3 meters, you should use a thicker wire than the above calculation because there is a large voltage drop during charging. If the ambient temperature is above 40 degrees, you may also need to use a thicker wire than the above calculation.

If the charging current is 60A --> at least $60 / 3 =$ at least 20 mm²--> select standard 25 mm²wire.

The use of wires that are too thin for the current will cause the wires and connectors to deteriorate in the long run, resulting in fires.



Set the charge current setting lower than the allowable charge current of the battery you are charging.

Set the charge voltage setting lower than the allowable charge voltage of the battery you are charging.

3. list of specifications

Tabos Development / Direct Production (Made

in Korea)

No	Item		Model Name : TC-3500W-50V60A	Remarks
1	Authentication		CE (TUV), FCC CB (TUV) : Certificate No. DE3-HS00641 Applicable standards : IEC 60335-1,2 , IEC 61000-6, Class A	
2	Applied Battery	Li-ion and Iron phosphate batteries < Batteries with other nominal voltages within the same range as the one on the right >	◇ Applicable to batteries with a nominal 48-52V range : Lithium-ion batteries (including polymer) 13-14S, lithium iron phosphate 15-16S *Factory default charging voltage: 57.0V *Charging voltage adjustment: Min. 52V ~ Max. 58.0 VDC / 0.5V increments available *Note (14S lithium-ion batteries): 56V setting: approximately 90% battery charge, 58V setting: approximately 95% battery charge	The customer's maximum battery charge voltage specification Set the maximum charge voltage on the LCD window.
3	DC charging voltage	Maximum battery voltage at full charge	52.0 VDC~ 58.0 VDC (Charging voltage can be adjusted in 0. 5 V increments on the LCD display)	Factory-set charging voltage= 57V (Users adjust the charging voltage to suit their situation.)
4	DC Charge Current	Current adjustable, Charge Current Ripple Reduction	10A to Max. 60A, (3% or less charge current ripple) (Charging current can be adjusted in 5A increments on the LCD display)	Factory-set charging current = 40A (The user adjusts the charging current to suit the situation.)
5	Parallelism features	Run up to four in parallel (Master / Slave	Parallel operation of up to 4 units Output DC 60A * 4 parallel= Increase output DC to 240A	

No	Item		Model Name : TC-3500W-50V60A	Remarks
6	DC charging power		Up to 3,480W (= 58V * 60A)	
7	Battery charge	Battery charge at full charge	Approximately 94 (Results from limiting the charging voltage to 58V Max for safety)	
8	DC End-of-Charge Current	View as full and end charge (about 10% of the charging current)	Approx. 5 A	
9	Recharge start voltage	If the charger has a battery in the	The battery remains plugged into the charger and charges to a full charge before shutting down. After that, if the voltage drops, it will start charging again, and the resumption voltage is called the resumption voltage.	
			* Recharge Voltage= Set maximum charge voltage (set by user in LCD window) (-) 2V lower value. Example) If you set the maximum charge voltage to 56V, recharge will work at 54.	
10	DC charging wire thickness	Room temperature guidelines	25 mm ² (= 60A/ (3A/mm ²) or more) / KIV wire	
10-1	DC Output Terminal Screw	SEMS Hex Wrench Bolt	Tightening torque : 25 (kgf*cm)	
11	Charging methods		Constant current/constant voltage type, CC/CV (Constant Current/ Constant Voltage), gradual increase in current after charging starts (Slow Start)	
12	Charger format	Isolated	Isolated charger with transformer-isolated primary (AC power supply) and secondary (DC charging) sides (A feature that prevents an internal failure of the charger from causing primary power to go directly to the battery.)	
13	AC Input Voltage	RMS value	Single-phase 200 VAC~ 240 VAC / 50 to 60 Hz	
14	AC Input Power, Current	RMS value	Approx. 4,000 VA, 18 A (AC220 V, battery charge 60 A)	
			When using a reduced battery charge current value, the AC input current can be calculated as a percentage of the charge current. (Calculation example) : If 40A is charged, AC input current is (40A/60A)*18A=12A	

No	Item		Model Name : TC-3500W-50V60A	Remarks
14-1	Leakage current	AC Input Line	<p>Leakage current measurement When measured by clamping the L, N, and E wire sheaths with a clamp meter, the leakage current is 2 to 2.5 mA or less.</p> <p>*Note: Tests with special leakage current test equipment according to KC/IEC/EN 60335-1/-2-29 have been passed. (CE, KC)</p>	
14-2	AC Input Terminal Screw	SEMS Cross Pot Head Bolt	Tightening torque : 12 (kgf*cm)	
15	Power switch	(Power switch located next to the LCD)	20A rocker switch	
16	AC incoming wire (bold, ringterminal)		<p>(1) Wire color VCTF (or VCT) 3 Core, 4 mm² (= 18A/ (5A/mm²) or higher) * Note: Safe wire allowable current is 5A/SQMM, maximum 7A/SQMM</p> <p>(2) Connection ring terminal: Use ring terminal for M4</p>	<p>Allowable current for VCTF 3Cx 4 sqmm wires : 19.5A (at ambient40)°C</p> <p>Note: When designing, it is generally based on 40°C ambient temperature.</p>
17-1	General circuit breaker for AC incoming power wiring Recommended capacity for use (What you need to prepare)		<p>25A or 30A breaker for wiring (breaker ↔ charger)</p> <p>*Note: Breaker capacity= breaker rated current x 80% > load current. = 25A x 80%=20A > Load peak current 18A</p> <p> Caution: Do not use pig-nose (16A) sockets/plugs.</p> <p>* When using an outlet, we recommend using a European industrial socket/plug 3P (32A).</p>	<p>Pig-nose socket/plug (maximum current rating is 16A):</p> <p>This 16A figure is possible under the best conditions, and older units can heat up quickly and become dangerous. For safety reasons, 10A or less is appropriate.</p> <p>* Safety standard: Outlet current is 8A or less.</p>

No	Item		Model Name : TC-3500W-50V60A	Remarks
17	For AC incoming power wiring, install a ground fault circuit interrupter on the Recommended when using (What you need to prepare)		<p>We recommend the newest breakers available for converters. → aka "LS Electric SI Earth Leakage Circuit Breaker" (LS Electric / Model No. : EBS52FB-SI 30A) , Explanation : SI = Super Immune (Earth leakage circuit breaker with high immune function) Note: For LS Electric products, we recommend products with the "SI" character, even if they have a different model number.</p> <p>When using a regular ground fault circuit interrupter, there may be malfunctions that cause unnecessary tripping, which is where the SI type ground fault interrupter above comes in. This ground fault interrupter is the latest generation of ground fault interrupters developed for converters, minimizing malfunctions. See the detailed documentation immediately below this table.</p>	
18	AC Standby Power	RMS value	Standby current = 0.5A at 220V, where power factor = 6.6%, Standby Apparent Power= V x A = 110 VA Standby Active Power = Standby Apparent Power x Power Factor = 110 VA x Power Factor (6.6%) = 7 W	Standby active power = 7 W
19	Efficiency /Power Factor		Efficiency Max. 91% , Power Factor Max. 98	At maximum output
20	Lithium batteries Protection		Output side short circuit protection / Charge over current protection / Charge over voltage protection / Charge reverse disconnection protection / Pre-charging function / *BMS/PCM unblocking function * BMS/PCM : Li-ion Battery Management System / Li-ion Battery Protection Circuit Module	
21 -1	Connectors for Enable Switches	(Enable Connector)	This connector must always be in the shorted state for the charger to operate. An emergency switch (N.C Type) can be connected to this connector to stop charging in case of emergency. Current flowing in the Enable S/W circuit = 100 mA	

No	Item		Model Name : TC-3500W-50V60A	Remarks
21 -2	External temperature switch connector	(External Thermal S/W Connector)		When charging the battery through the charging contactor, the contactor sometimes overheats. To prevent this, a thermostick (Normal Open Type) can be mounted on each of the contact electrodes (+)/(-) and connected in parallel to this connector. In this case, if the thermostat overheats and turns ON, the charger will stop charging and send an error signal.
22	Safety features			<ul style="list-style-type: none"> * Charger self-protection in case of short circuit / * Battery overcharging and overcurrent charging protection / * Fault protection in case of reverse connection * Prevent power output from the output terminal when a battery is connected / * Stop charging when connecting a battery of another model
23	Operating Temperature Conditions			Driving : -20°C ~ +40°C / Storage : -20°C ~ +65
24	Size/Weight			W 107mm x H 227mm x L 462mm , 7.7Kg
25	Auto Mode Operation			<p>When set to Auto Mode on the LCD monitor screen, it automatically detects the connected battery, determines if a suitable battery is connected, and charges it. Once fully charged, it automatically stops charging. If the battery is removed during charging, the output is automatically cut off. Even if the charging cable is disconnected during charging, this design ensures it does not affect device performance and prevents sparks.</p> <p style="text-align: center;">In Auto Mode, communication devices (DIO, RS485) are only available for monitoring.</p>

No	Item		Model Name : TC-3500W-50V60A	Remarks
26	External Control Communication Device-1/2 (Standard Equipment)	Charging ON/OFF Control and Monitoring	<p> 〈 1. When set to AUTO mode on the LCD monitor 〉 Charging operation occurs automatically. The communication port is used solely for status monitoring. Charging ON/OFF control is not possible via communication. Monitoring can be performed using both DIO and RS485 simultaneously. </p> <p> 〈 2. When set to REMOTE mode on the LCD monitor 〉 Method (1): DIO (Digital Input/Output) → Molex connector 8POS Method (2): RS485 → DSUB 9-Pin (Female) Connector / Allows adjustment of charging voltage and current via communication, enables reception of detailed error data. </p> <p> Note 1: If wired to the DIO port, the DIO signal automatically takes priority for charging control without separate configuration. When both the DIO port and DSUB 9Pin connector are connected simultaneously, DIO takes priority for charging control. However, monitoring signals are transmitted not only to DIO but also to the DSUB 9Pin connector. </p>	
	External Control Communication Device -2/2 (Customer must purchase and apply a separate communication converter)	(Continued from previous)	<p> Method (3): Bluetooth Wireless Communication→ A separate Serial to Bluetooth Converter (commercially available). Refer to separate TABOS documentation. </p> <p> Method (4): Ethernet (LAN) Communication→ A separate Serial to Ethernet Converter (commercially available) can be purchased for use with the RS485 port / DSUB 9Pin. Refer to separate TABOS documentation. (commercially available) can be purchased and used. Refer to separate TABOS documentation. </p>	

No	Item		Model Name : TC-3500W-50V60A	Remarks
27	Optional products sold separately (Control panel switch)	Type : TWC-TX-STA-PNL	<p>(Configuration)</p> <ol style="list-style-type: none"> 1) Indicator light: green (charging), green blinking (full), yellow (standby), red (error) 2) Selector switch: 2-speed / Standby & Charge 3) Pushbutton Switch: Error Reset 4) Emergency switch: for emergency shutdown of the charger <p>(install, run)</p> <ol style="list-style-type: none"> 1) Simply plug this product into the connectors (communication line and power) of the charger body. (Harness supplied) 2) Power supply via AC220V power outlet <p>(Advantages of this device)</p> <ol style="list-style-type: none"> 1) Interconnect the charger with the main control panel switches, and set the charger to Manual mode in the LCD setup window for convenient use without the need for any 	

Note: Recommended earth leakage disconnectors are described in an addendum at / Not required to use these

When using a regular ground fault circuit interrupter, there may be malfunctions that cause unnecessary tripping (depending on the site conditions), which is where the SI type ground fault interrupter comes in handy.

LS Electric SI Earth Leakage Circuit Breaker → **Features : Enhanced harmonic immunity, enhanced overload current immunity**
Products with the letters "SI" in the model name. SI = Super Immune (Earth Leakage Circuit Breaker with High Immunity)

This is a newly developed breaker for switched power supply (SMPS) loads. Tabos chargers are also a type of SMPS.

Type SI ground fault interrupters are equipped with a feature that prevents harmonics generated by the SMPS load from causing the ground fault interrupter to malfunction and trip (OFF).

A new type of ground fault circuit interrupter that has a microcomputer chip inside the breaker that monitors the power situation and only trips when it needs to.

LS Electric's SI circuit breaker can detect the fundamental wave component of the leakage current and distinguish the current that should be operated from the current that should not be operated, thus solving the malfunction problem.

Source: electimescom.com. keyword: LS Electric SI circuit breaker

LS일렉트릭, 오동작 내성형 누전차단기 시장 니즈 맞춰 제품개발
누설전류 성분 검출 알고리즘 적용, LED조명 등 비선형부하에 적합



LS일렉트릭이 올 2월 출시한 이 차단기, 고조파와 과도상 시지(Surge) 전류로 인한 기존 누전차단기
의 오동작 문제를 해결한 제품이다. (제품:LS일렉트릭)

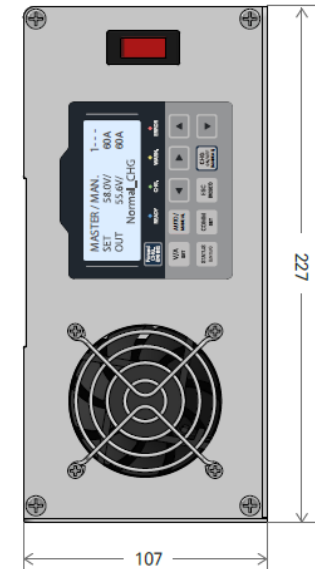
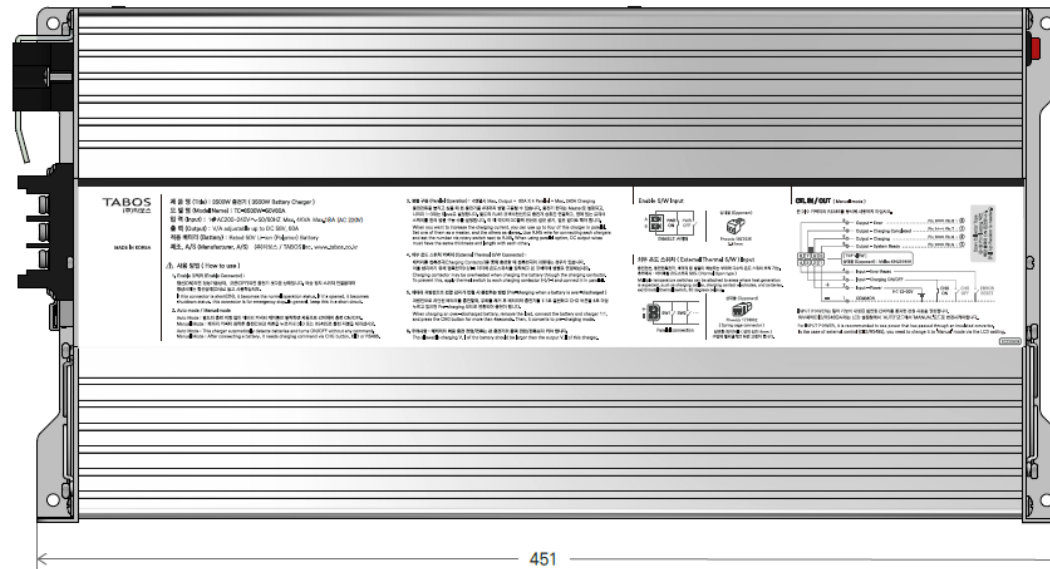
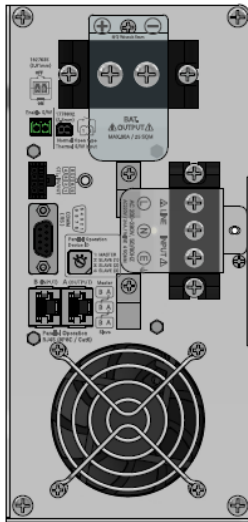
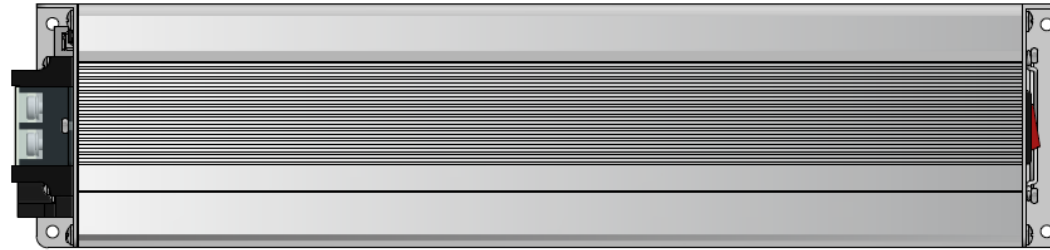

5. safety management functions / product features / charging process description

No glitches or sparks.

This means that **there is no sparking** that normally occurs **the moment you connect** the charger to the battery for charging.

(How to use this charger accordingly):

Simply connect the charger and battery to charge without any action while the charger is powered on, and remove the connecting wires when charging stops. There is no need to cycle the charger power on/off. Powering the charger on and off is not good for charger durability.

No electricity is output from the output terminal when the battery is not connected. → Safety Features.

If there is no wire connection to the battery, no charging current will be output to the charger output terminal even if the charger is powered on.

③ Reverse connection protection

The battery reverse polarity connection detector prevents the battery and charger from failing if the battery polarity (+) / (-) is reversed at the charger output terminals. Once the user corrects the connection, normal charging is possible.

In the event of a reverse connection, will activate the reverse connection protection. (The LCD monitoring window will not show this.)

④ Prevent battery overcharging and overcurrent charging

Rest assured, you won't be overcharged beyond the set charge voltage and charge current.

Primary and secondary isolation function:

The battery will not be overvoltage even under adverse conditions (such as charger burnout and internal short circuits).

The primary AC power supply and the secondary output DC power supply are electrically isolated using a transformer.

This means that the primary power (AC220V) will not be transferred to the secondary side (battery charging) even if there is an internal failure, short circuit, fire, etc. of the charger. In other words, it is safe for charging lithium batteries because the battery will not be subjected to overvoltage due to internal failure of the charger.

(Note) :

When charging a lithium battery by connecting an uninsulated charger to the battery, if the battery (+) / (-) wires touch the ground (ground fault), the AC power breaker will usually trip. If there is no breaker or if the breaker is overcapacity, the lithium battery may be damaged. (Battery hazards)

⑥ Self-protection and automatic restoration in case of short circuit

During standby (when battery is not connected) status, the output line will automatically detect a short circuit and shut off the output, and will automatically return when the short circuit is cleared.

⑦ Stop charging when connecting a battery from another model:

For example, if a 25V battery is connected to a 50V charger, it thinks a different model battery is connected and will not charge it.

-----기 타-----

⑧ This charger is equipped with a terminal to which an emergency switch can be attached, which is useful for fire prevention. :

Roughly 90% of battery fires happen while charging.

There is a terminal for connecting an emergency switch so that the operator can immediately stop the charger if a smoke light abnormality is detected on a battery being charged. Alternatively, a separate Tabos optional product, the control panel (with emergency switch and warning light) can be attached.

This charger is equipped with a terminal to which an external temperature switch can be attached, which is recommended for fire protection. :

Battery fires sometimes start on the charging wires that connect to the battery.

By installing multiple temperature switches at locations (such as wire connections) where there is a risk of overheating of the charging cord, you can prevent the charger from causing a fire.

-----Equipped with safety-conscious charging process algorithms-----

⑩ Have a process for safe charging

(Ability to determine if the battery connected to the charger is a different model that should not be charged and take action)

>> By Ready mode step,

1. Enter battery voltage check mode when a voltage of 30V or more is detected at the battery terminals.
2. In battery voltage check mode, start charging when 40V or higher for 1 second. Battery check mode disengages when 10V or less for more than 1 second.

That is,

Above 30Vdc, it will respond, and below 40V, it will only repeat the voltage check behavior. Charges at 20A constant current from 40Vdc and above to 46V and below.

>> Except in forced charge mode. <<

If you connect a 7S battery, mistakenly force charge it, it will stop after 15-20 charge attempts unless the voltage level is 42-44V.

If you continue to make the mistake and force charge, the battery's protection circuitry (BMS) will eventually shut off the charge.

6. How to use General

6-1. LCD window display and inputs



- A. **[V/A SET] button** --> Max Charge Voltage, enter the maximum charge voltage.
- * The LCD monitor window displays the set value in the upper line and the actual value being charged in the lower line.
 - * **Press and hold this button to adjust the Max Charge Voltage and Max Charge Current values.**
- B. **[STATUS (ENTER)] button** --> Checks the status of settings and errors and doubles as the 'Enter' button.
- C. **[Auto/Manual] button** --> What you need when not using the external control communication method.
- * Auto Mode: When the battery is connected, the charger automatically detects and starts charging.
 - * Manual Mode : Press [CHG ON/OFF] button to charge or command charging using external control communication (DIO, RS485).
- D. **[COMM SET] button** --> Select external control communication method < RS485 communication setting >
- * If the DIO control is not set with the [COMM SET] button and only the DIO port is wired, the DIO control will be disabled.
 - DIO control automatically takes precedence and executes the command.
 - * DIO controls take precedence over other controls.
 - For example, if RS485 command and DIO control are connected simultaneously, charge control is performed based on DIO command. However, monitoring information is provided simultaneously with DIO via RS485.
- E. **[CHG ON/OFF] button** --> Charging ON/OFF control when in Manual Mode (Manual Control)



6-2. How to Force Charge / Charge When Battery is Overdischarged (Forced-charging when a battery is over-discharged)

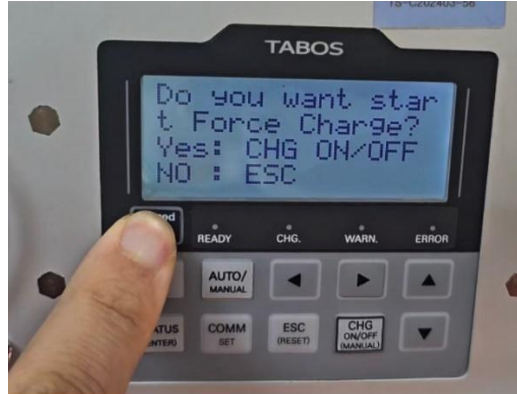

- ① Press the AUTO/MANUAL button to switch to MANUAL mode.
- ② If you press the Forced CHG button for more than 4 seconds, a dialog will pop up asking if you want to force charge. (See screen)
- ③ Pressing the CHG ON/OFF button will then start the forced charge.

Caution:

When charging a battery that has been shut off due to over-discharge, remove the load and leave the battery and charger wired 1:1.

In some cases, the battery may be damaged, and it can be dangerous to force charge it.

To avoid this issue, this force charge behavior should be performed with an operator watching from the sidelines.

If an abnormality is detected (battery making strange noises, smoke, etc.), charging should be stopped immediately.

When the battery is charging normally, it will automatically come out of forced charge mode and charge the battery in normal mode.

◇ Force Charge Behavior Description :

(Models shipped after January 2024)

< 55 seconds charge at 50V/ 5A 5 seconds rest > / cycle → Repeat this cycle 15 times. (total time about 15 minutes),

Raises an error if this behavior doesn't bring the battery back to life.

(Models shipped before December 2023)

< 20 seconds charge at 50V/ 5A 5 seconds rest > / cycle → Repeat this cycle 7 times. (Total time about 3 minutes),

Raises an error if this behavior doesn't bring the battery back to life.

6-3. Enable Connector for Switch :

When shorted (ON), the charger is in normal operation; when open (OFF), the charger is shut down. This is for connecting an emergency stop switch, and Normally, the charger must be left shorted (ON) to start.

Enable S/W Input

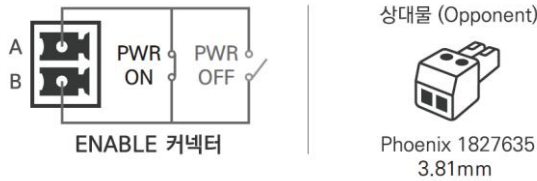

6-4. External Thermal S/W Connector :

(Enable options / Use as needed)

When charging the battery through the charging contactor, the contactor sometimes overheats. To prevent this from happening, the contact electrodes (spring contact electrodes, contact shoes, wire connections, etc.

A thermostat (NO / Normal Open Type) can be fitted and connected in parallel to this connector.

When we talk about a thermostatic switch, we're talking about a switch that turns on when it's above a certain temperature.

An unlimited number of thermostats installed in different heating locations can be paralleled and connected to this connector, as shown in the figure below. Each thermostat can also have different operating temperatures.

If any of the multiple temperature switches are overheated and turned ON, the charger will stop charging and send an error signal.

These errors are cleared only by cycling the charger power.

*Note / How to fix the temperature switch: Use a shrink tube or cable tie to the surface of the power cable where heat may be generated during charging (AMR/AGV battery charging contactor, etc.) or the power cable connected to it.

외부 온도 스위치 (External Thermal S/W) Input

충전전선, 충전접촉전극, 배터리 등 발열이 예상되는 부위에 다수의 온도 스위치 부착 가능.
추천예시 : 바이메탈 온도스위치 50도 (Normal Open type)

Multiple temperature switches can be attached to areas where heat generation is expected, such as charging cables, charging contact electrodes, and batteries.
ex) Bimetal thermal switch, 50 degrees celsius.

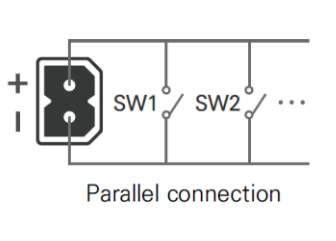

상대물 (Opponent)

 Phoenix 1778832
 (Spring cage connector)
 탈피한 와이어를 (탈피 길이 4mm)
 구멍에 찔러넣기만 하면 고정이 됩니다.

(Thermostat example): Key words: thermostat, bimetal thermostat,

■ Temperature switch types: There are several types, including rod and disc.

The key element is that N.O. (A contact) switches must be used.



■ Temperature Switch Recommendation: PROTHERM PT-01 R-Type A-Contact Open-to-Close (I recommend this company's temperature switch because A-contact products are readily available online.)

Search Keywords - ◇ "PROTHERM A-Contact 60°C Temperature Switch PT-01 R60C"

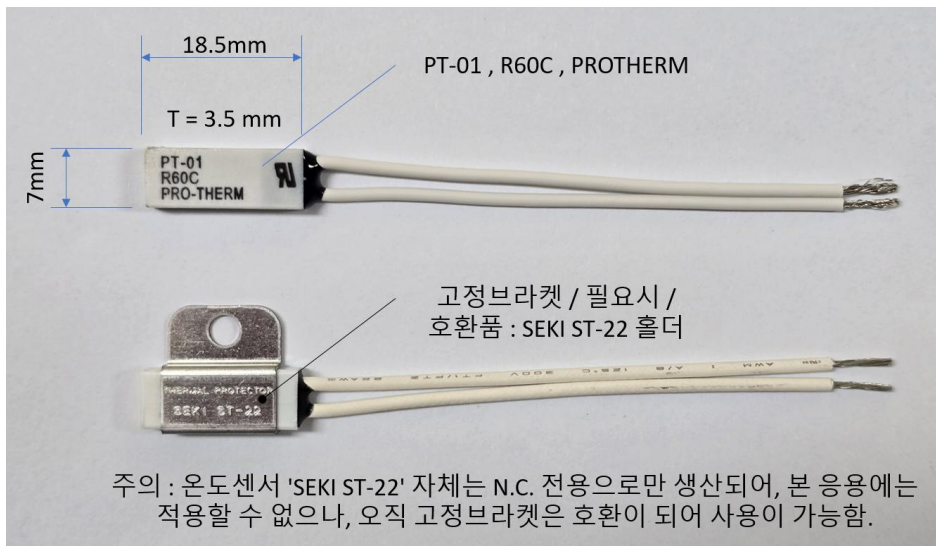

■ Bimetal Temperature Switch Specifications:

① Temperature switch allowable current: 100mA or more. ↓- Specifications required by the temperature switch input of the TABOS charger.

② N.O. (Normal Open) Type = A contact. / Inspection Method: Measure the resistance of both legs with a resistance tester and the value should be infinity.

③ Recommended operating temperature: 60°C.

④ Operating temperature tolerance (error) = $\pm 5^{\circ}\text{C}$ or less.

◇ Calculation: Select a temperature 20–25°C higher than the ambient temperature. Ambient temperature: $35^{\circ}\text{C} + 20\text{--}25^{\circ}\text{C} = 60^{\circ}\text{C}$.

◇ Verification: The typical heat-resistant temperature of vinyl-insulated wire (VCT, VCTF) is 70°C, but this is a 10°C margin.

■ Caution: I'm sharing my experience purchasing a TABOS product below.

- When purchasing a temperature switch from a popular online shopping mall, even if you specify NO (A contact) as the option, you often receive an NC (B contact). Be sure to use a resistance tester to verify that it's an NO switch.

- SEKI temperature switches are frequently searched for online, but when I contacted the company, they said they only produce NC switches and not NO switches.

- KSD temperature switches are frequently searched online, but it seems only the NC type is produced and sold. TABOS attempted to purchase the NO type 4–5 times from different shopping malls, but the NO type was never delivered, and the NC type was delivered, making it unusable.

6-5. Auto mode / Manual mode

A) Auto Mode :



Use the Auto/Manual button in the LCD window to set it to Auto.

Once set, the mode is permanently memorized and not erased when the charger is powered off.

(Factory Default → AUTO Mode)

This mode automatically detects and turns the charge ON/OFF when the battery connector cable is removed without any charge instruction. If no battery is connected at this time, no voltage is output to the charger output terminal. (0V)

When using this charger for AMR (robot), AGV (automated guided vehicle), etc. to set up a charging station (docking method using contact electrodes)

Another option is to use Auto Mode, a feature of this charger.

Auto Mode is set to Auto Mode using the 'Auto/ Manual' key on the switch on the charger's LCD window while the charger is always powered on. When the AMR or AGV arrives at the charging station and docks to the contact electrodes, the charger detects the battery voltage and automatically charges the battery. At this time, no electricity is sent to the charger output terminal in the standby state when the battery is not connected to the charger. (Output voltage 0V)

B) Manual Mode :

Set to Manual mode using the Auto/Manual button on the LCD window.

Once set, the mode is permanently memorized and not erased when the charger is powered off.

Connect the battery to the charger output and press the charge (CHG) button on the LCD window or send a charge command to the communication port DIO or RS485 to charge the battery.

◇ Sequence of operations :

Dock to robot (AMR, AGV) charging station --> Command charger to charge ON --> (Perform charging action)

--> tell the charger to charge OFF --> the charger sends the robot a signal to stop charging and shut down

--> Return charging station electrodes and depart robot

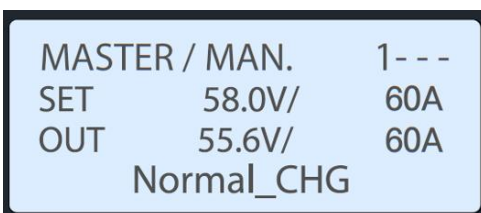

Status display at the top of the LCD window : MAN.

(Manual) / AUTO

6-6. Parallel Operation :

You can run up to four of these chargers in parallel if you want to increase the charging current. One charger is set as Master, and the other 1-3 are set as Slaves.

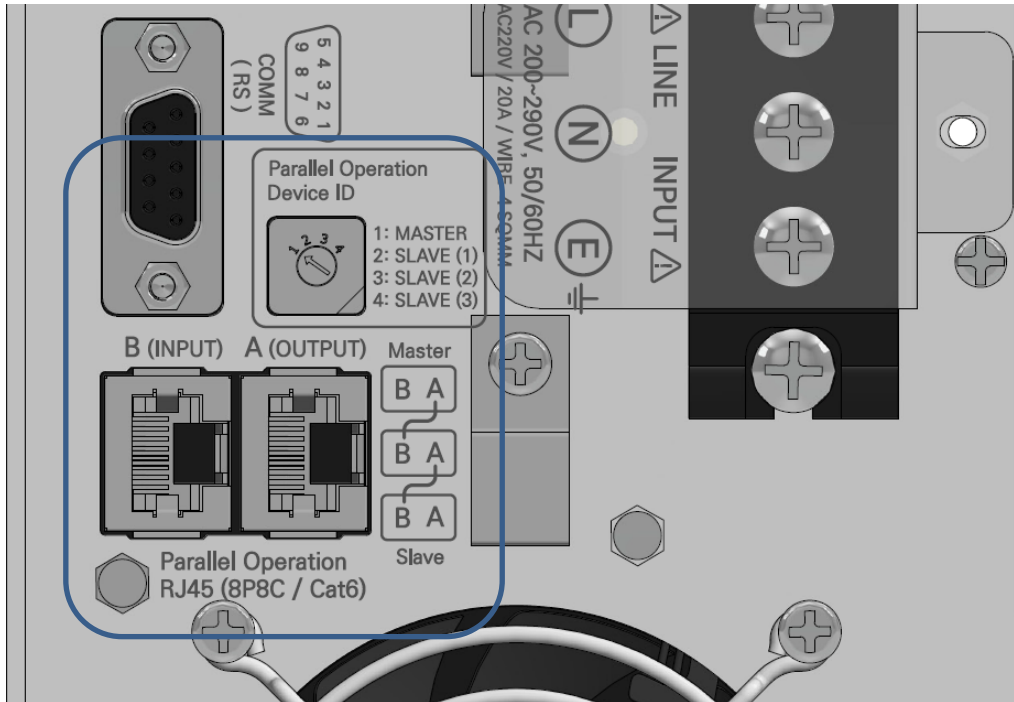

Connect the chargers to each other with separate RJ45 connector wires and set the number of parallel runs by turning the rotary switch next to them. Once the RJ45 connectors are properly connected, the LCD window will automatically display Master and Slave.

When running in parallel, you do not need to make any settings in the LCD window. However, you only need to set the total output current on the charger that is set as Master.

(Example) : Max. 60A * 3 in parallel= Max. 180A

If you run them in 3 parallel, but the current set by the Master is 100A, then each charger will output 33A, which is 1/3 of the value.

⚠ Note: The battery connection wires (DC output wires) must each be the same thickness and the same length.

6-6-1. Parallel Drive Wiring and Operation

*Note: DC output (charging) wire thickness selection criteria for parallel operation → Apply 3A per 1sqmm wire thickness → 3A/sqmm, which is a sufficient size to avoid voltage drop across the wire.

(Example 1) : For 2 parallel operation → 60A/each * 2 parallel = 120A , final output wire thickness = 120A / (3~4A/sqmm) = 35sqmm wire → 2 parallel wire joining part is recommended to use busbar.

(Example 2) : For 4 parallel operation → 60A/pcs * 4 parallel = 240A , final output wire thickness = 240A / (3~4A/sqmm) = 70sqmm wire → In this case, use busbar.



6-6-2. Understanding the 'COM_SET' button of the LCD monitoring window for parallel operation

The parallel drive is using CAN communication mode.

However, there is no special 'COM_SET' to be set by the user when running in parallel.

The following is a reminder



Press the 'COM_SET' button and you will see the screen on the left.

When it comes to parallelism, the only settings the user can change are the
CAN RT : (Terminal resistance ON/OFF setting for charger parallel operation

For the last charger set as a slave, it can also be set to CAN RT:ON.

However, general parallelism is not possible with
In this case, the communication line (RJ45 jack) connecting the charger to each other has a short ground pole, so there is no problem even if CAN RT : OFF is set.

Note that the

RT / Resistor Termination is the last end of the cable, which sometimes causes poor communication due to echo phenomenon when parallel communication is performed.

The last charger on the cable is the one that turns on the termination resistor to eliminate poor communication due to echo.

If the length of the communication cable is short (1~2m), leaving the termination resistance (RT) OFF will not cause communication failure.

6-6-3. Parallelism Related Photos

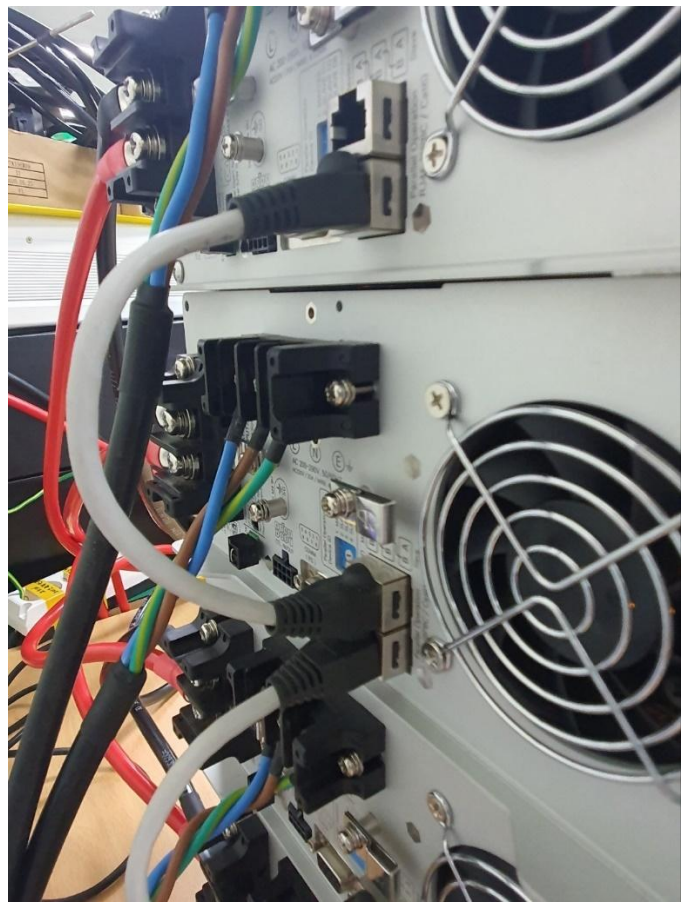
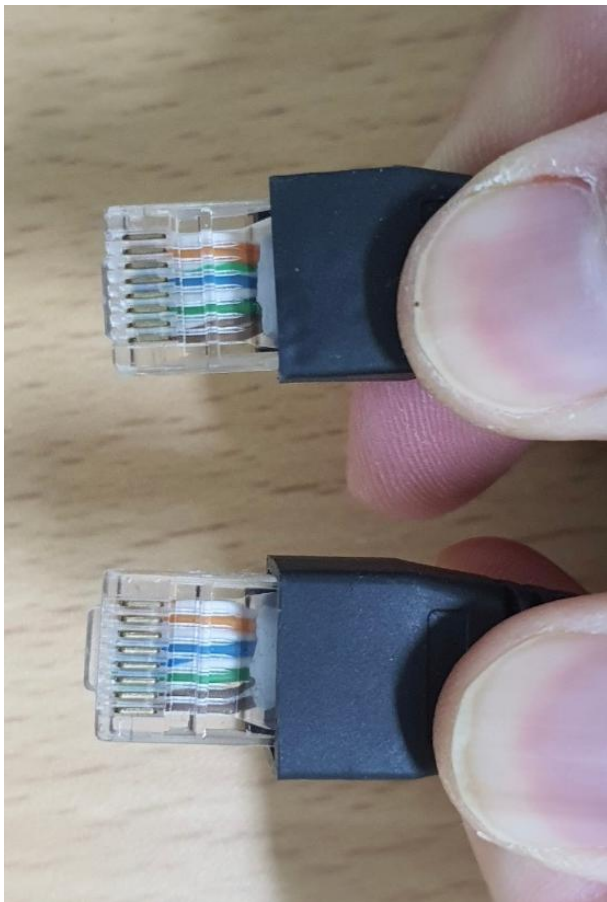
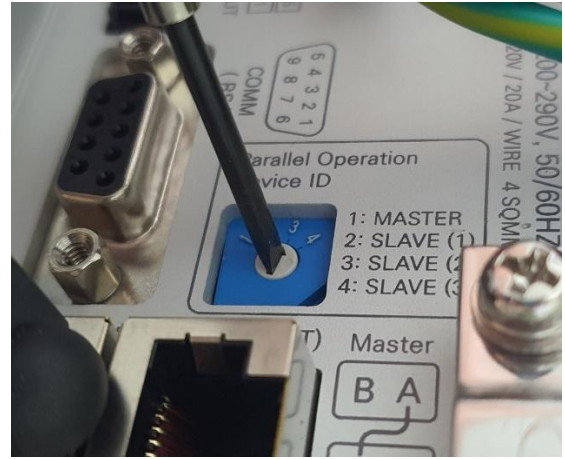
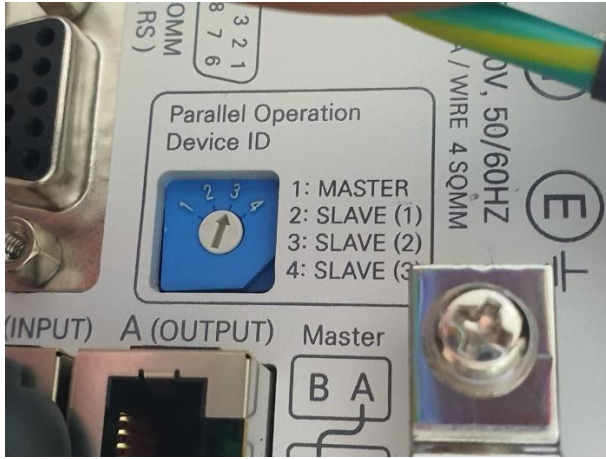

7. settings and external control methods

7-1. External Control with DIO / Digital Input Output

⚠ Caution1 : When using the 'Charger Control Panel', connect the DIO cable connector attached to it to this DIO connector.

Therefore, when using the charger control panel, this DIO port cannot be used for any other purpose. There is only one DIO port.

In this situation, use RS485 communication.

⚠ Note 2 : When this DIO connector is connected, DIO control is automatically prioritized and operated without any setting (no need to set it in the LCD monitor's menu).

CTL IN / OUT (Manual mode)

본 DIO 커넥터와 RS485를 동시에 사용하지 마십시오.

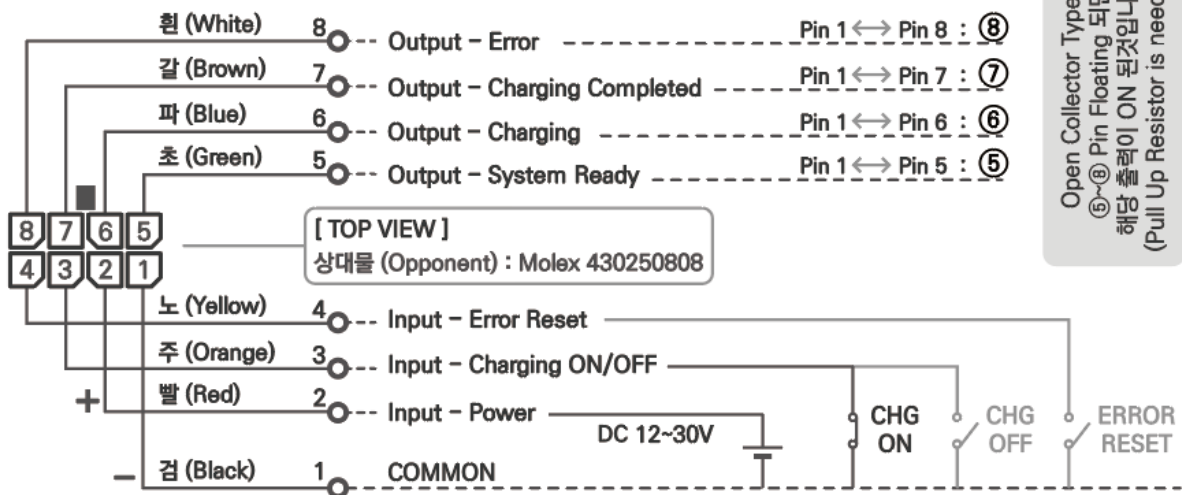

INPUT POWER는 필터 기능이 내장된 절연형 컨버터를 통과한 전원 사용을 권장합니다.

외부제어(DIO/RS485)시에는 LCD 설정창에서 'AUTO' 모드에서 'MANUAL'모드로 변경시켜야합니다.

For INPUT POWER, it is recommended to use power that has passed through an insulated converter.

In the case of external control (DIO/RS485), you need to change it to 'Manual' mode via the LCD setting.

* Note 1: If you want to use DIO and RS485 at the same time, you can do as follows.

< DIO communication --> command and monitoring, RS485 communication --> use monitoring only >

* Note 2 : When using DIO OutPut signal outputType can be changed by the user in the setting window as shown below.

This charger's LCD window / Setting menu / DIO OUTPUT Type / 'NORMAL' Type and 'REVERSE' Type . You can select it as a Type. The default mode is 'NORMAL' Type.

The output signal (High / Low) level is inverted compared to the NORMAL type, which is called REVERSE type:

NORMAL' Type : Input signal corresponding to ON signal becomes Low, output signal becomes High

REVERSE' Type : Input signal corresponding to ON signal becomes High, output signal becomes

Low. See the schematic below (CASE 1)

(1) Basic structure of the Out Put circuit of DIO (Digital Input / Output) circuit→ Open Collector method

This is done by attaching a pull up resistor on the user's side. (See figure below.)

***Output/Monitoring:**

When pins 5 through 8 (Pin B) and pin 1 (-)Common) are floating, the corresponding signal is output.

In other words,

- ◇ When pins B and A are open (the transistor output terminal in the diagram below is open), the corresponding signal is output.
- ◇ When pins B and A are short (the transistor output terminal in the diagram below is short), the signal is in standby mode.

(Case 1) High / Low Signal 확인용

*주의 : DIO / Output = ON ---> 출력 = ON (High), 즉, 입출력 신호 레벨(High/Low)이 정방향으로 같음.

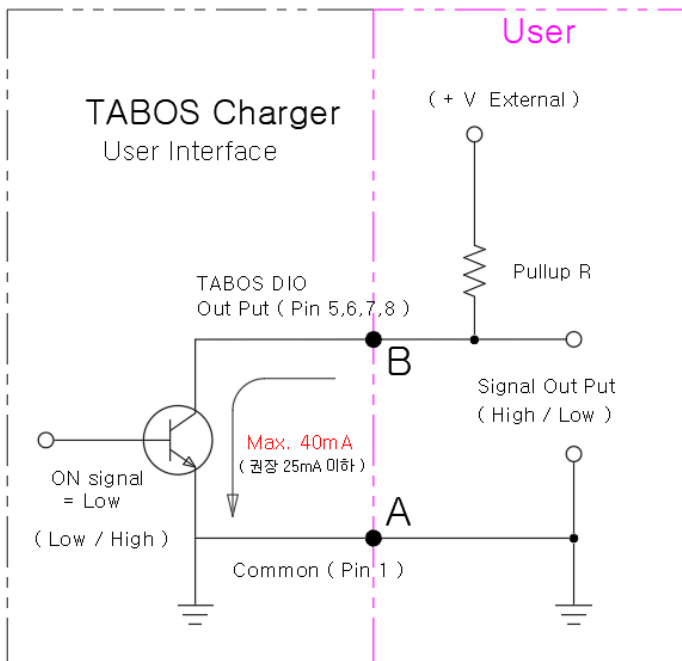

Pull-up resistor reference values:

At 24V, R = 1.8KΩ · Current = approximately 10mA

At 12V, R = 0.9KΩ · Current = approximately 10mA

***Signal output example**

READY	Charging Standby ↓	When not charging ↓
	Between (Pin A) and (Pin B): OPEN	Between (Pin A) and (Pin B): CLOSED
CHG	Charging ↓	When not charging ↓
	Between (Pin A) and (Pin B): OPEN	Between (Pin A) and (Pin B): CLOSED
Charging Complete	Charging Ended ↓	When charging is not complete ↓
	Between (Pin A) and (Pin B): OPEN	Between (Pin A) and (Pin B): CLOSED
Error	Error ↓	When not an error ↓
	Between (Pin A) and (Pin B): OPEN	Between (Pin A) and (Pin B): CLOSED

(2) Caution when using DIO output line

Pins 5,6,7,8 Output are signal wires and are used to check high/low, not to consume power. The maximum allowable current for this output signal wire is 40 mA, recommended 25 mA.

If more than this current is drawn, the DIO circuitry inside the charger will burn out or become unusable. Therefore, this signal cannot be used to directly drive a magnetic relay (coil type) or directly drive a high-power LED.

If you want to attach a relay to this signal line, we recommend a FET or SCR (Silicon Controlled Rectifier) with low current drive. Make sure that the gate drive current is 25 mA or less.

Also, if you want to attach a signal LED, you can usually use 10mA or less for signal LEDs with a diameter of 5mm or less, but you need to make sure that it is within the allowable current.

(3) Analyze DIO Output Line Use Cases

If you want to drive large power using the DIO output lines, you can do so in the following ways.

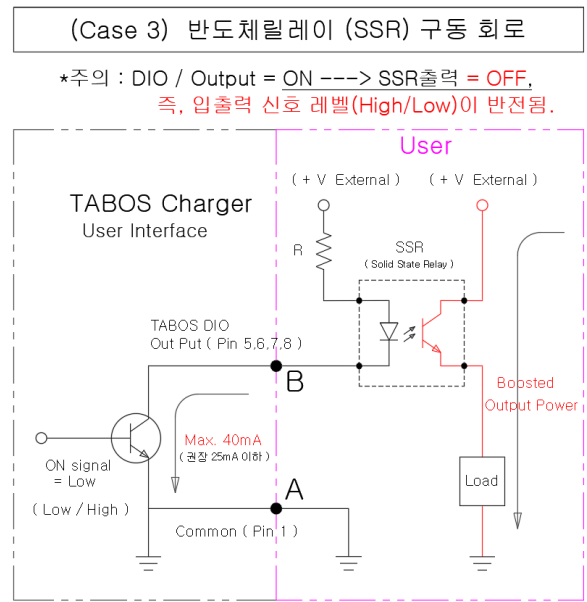
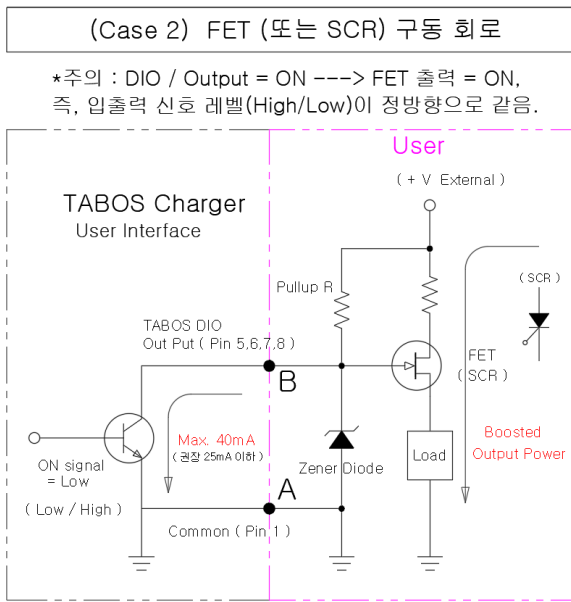

■ See "When using (CASE3) SSR" above for cautions and help:

*If you configure the SSR(Semiconductor Relay) circuit as above, you need to change the DIO Output Type to the following.

- This charger's LCD window / Setting menu / DIO OUTPUT Type / 'NORMAL' Type
- 'REVERSE'

You need to replace it with Type.

An action to reverse inverted input and output signal levels.

*Recommended SSR (Semiconductor Relay) : Model S4T-16P-202D / 4-channel type / Ring terminal type

(4) Type / Command

When pin 3 and pin 1 '(-)Common' are short-circuited (closed), this is the command to start charging.

Reset sign is entered when pin 4 and pin 1 '(-)Common' are short-circuited (Closed)

(i.e., an ON signal is input when a conductive state is created between the input terminal and pin 1 '(-)Common' terminal.)

If an error occurs and the error reset command fails to cancel, first check the error on the LCD monitor and take action.

In some cases, you may need to turn the ENALE terminal (or power switch) off and then back on again.

(5) Do I have to use 12V or 24V for the DIO power supply voltage?

5V or higher is fine. However, the pull-up resistor must be properly selected and mounted for this voltage.

A 3.3V input will work, but we recommend using 12V or 24V because higher voltages are more stable.

7-2. Control by connecting to the control panel (option product) using DIO --> Refer to Contents / How to connect to the control panel

7-3. External Control via RS485 Communication / Using D-SUB 9Pin Connector

< See separate documentation for RS485 communication protocols. >

7-3-1. Cautions

- When a D-SUB 9Pin connector is connected, D-SUB 9Pin control is automatically enabled without any settings.
- RS485 communication (D-SUB 9Pin) and DIO communication can be used simultaneously. However, it can be confusing to issue both charge and end charge commands at the same time, so it works as follows.

If the command to start charging is sent to the DIO, the command to end charging must be sent to the DIO.

(In this case, RS485 communication is only monitored; it does not listen to the end-of-charge command via RS485 communication).

And then

If the next charge is commanded with an RS485 command rather than a DIO command, the RS485 will be prioritized and the charge will start. The end of charge command must be issued via RS485.

(In this case, DIO communication is only monitored; it is not listened to when a command to end charging is issued over DIO communication.)

7-3-2. Example of using RS485 communication (D-SUB 9Pin) and DIO communication at the same time

If you want to use DIO and RS485 communication together, you can use the following example.

(case 1) :

Command DIO to start and stop charging.

RS485 communication is for monitoring only.

(case 2) :

Issue commands to start and stop charging via RS485. Monitor at the same time.

DIO communication can also be used for status indicator monitoring, for example, to attach a separate LED signal lamp (or warning light).

7-3-3. RS485 Communication (D-SUB 9Pin) Pin Map D-SUB 9Pin / Female

RS485 PIN MAP		
핀번호	이름	설명
1	Vcc	+5V / 통신전원
7	DATA+	RS-485 POSTIVE
3	DATA-	RS-485 NEGATIVE
4,5	GND	GROUND

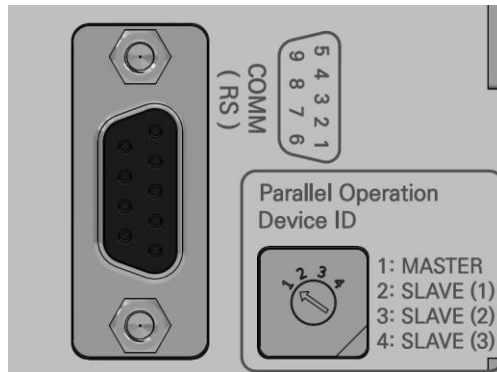

*Note: Pins 4 and 5 are short-circuited. You can use either pin 4 or 5 as GND.

7-3-4. Understanding the 'COM_SET' button of the LCD monitoring window to use external control RS485 communication

When the user controls this charger externally (RS485 communication), the settings on the monitor below are set to

You only need to set the RS485 ID and RS485 RT (termination resistance).

Note: CAN communication mode is only used for parallel operation of the charger.

This feature is not available to users for communication control.



Press the 'COM_SET' button and you will see the screen on the left.

The only settings that a user can change are the RS485 ID : <Address setting, 1,2, etc...>

RS485 RT : <Terminal resistance ON/OFF setting when controlling external communication of charger

< Below is for parallel operation of charger >.

CAN RT : <Terminal resistance ON/OFF setting for charger parallel operation> <Terminal resistance ON/OFF setting for charger parallel operation

Note that the

RT / Resistor Termination is the last end of the cable, which sometimes causes poor communication due to echo phenomenon when parallel communication is performed.

The last charger on the cable is the one that turns on the termination resistor to eliminate poor communication due to echo.

If the length of the communication cable is short (1~2m), leaving the termination resistance (RT) OFF will not cause communication failure.

Note :

Blue Tooth wireless and LAN communication methods are described later.

8. error and status messages

(The error list below is output to → and displayed on the LCD as well.)

* Note: Error auto-clear condition: when battery is removed or when error condition is cleared

Separation	Communication Code	LCD display text	Contents	Cause/Action	ErrorsAuto Off	Remarks
Behavior Bad	0	OUT CURRENT OVER	Output Current Overrun Error	80A or more detected / professional inspection and replacement required	X	
	1	out voltage over	Output Voltage Overrun Error	86V or higher detected / professional inspection and replacement required	X	
	2	CHG TEMP OVER	Internal Main Power Board Temperature High Error	When detecting above 60 degrees / bad temperature sensor or high operating environment temperature	X	
	3	pfc current ovdr	Input Current Error	Needs inspection and replacement	X	Detect 20A or more at 380V
	4	pfc voltage over	Input Voltage Error	Needs inspection and replacement	X	Detect 450V or higher
	5	PFC TEMP OVER	Internal Power Factor Correction Circuit (PFC) High Temperature Error	When detecting above 60 degrees / bad temperature sensor or high operating environment temperature	X	
External Bimetallic	6	ext. temp-h/stop	External Bimetal (Contact) Behavior Notification Error	External bimetal health check action required / <u>must power reset.</u>	X	<u>If the error still occurs after power reset, remove the bimetal temperature sensor and check the cause</u>

Separation	Communication Code	LCD display text	Contents	Cause/Action	ErrorsAuto Off	Remarks
Failed charge	7	OUT current ZERO	Charge Current Not Output Error	Battery voltage recognized, but current disturbance error. (after 5 seconds of inactivity) Final error after 5 retries / error automatically cleared when battery is removed.	0	
Failed charge	8	(not used)	-.	-.	-.	-.
Failed charge	9	BAT OVER VOLT	Overvoltage error at start of charge	Check voltage between Ready → Normal-CHG and error higher than 58.8V / Automatically clear errors when battery is removed.	0	
Failed charge	10	BAT UNDR VOLT	Low voltage error at start of charge	Check voltage between Ready → Normal-CHG for errors lower than 40.6V / Automatically dismiss error when battery is removed.	0	
Failed charge	11	BAT REVERSE	Battery (+) / (-) reverse connection status error	Check for reverse wiring. Note : Regardless of this error transmission, the protection operation and charging operation will be stopped in case of reverse connection.	0	The circuit is present, but the error indication is inactive. <u>Currently, in firmware 1.06, the battery does not charge when connected in reverse. No error display.</u> <u>(This feature applies from 2024.12 onwards)</u>

Separation	Communication Code	LCD display text	Contents	Cause/Action	ErrorsAuto Off	Remarks
Failed to start	12	Calibration ERR	Calibration errors	Sequence required at startup. Check/replace required if error occurs	X	
Failed to start	13	PFC Voltage LOW	Power Factor Correction Circuit (PFC) Low Voltage Error on Charger Power Up	Sequence required at startup. Check/replace required if error occurs	X	
Failed to start	14	UIboard COM OPEN	User Communication Board Errors	Sequence required at startup. Check/replace required if error occurs	X	
Parallelism	15	Parallel CH CHK	CAN communication address conflict error in parallel operation	Need to check communication address settings when running in parallel.	X	
Display Bad	-	LCD Data Line ER **Check Device**	LCD display device anomalies (affected by noise, surge, etc.)	Display unit only. No separate communication cord. Power reset or LCD check/replacement required. Display shows error, but no error in actual communication.	→	Automatic error cleared for normal LCD operation.

15. Efficient use of chargers and charging characteristics

Why it takes longer to charge than calculated and how to avoid it.

Or the battery's state of charge (SOC) value after charging is lower than expected.

Why and how to prevent it

(1) Understand the behavior of charging stages :

**** (Charge_step 1) / CC (Constant Current) mode charging:**

The Li-ion charger will charge to the set maximum charge current value as it starts charging.

**** (Charge_step 2) / CV (Constant Voltage) mode charging:**

As charging continues in CC mode, at some point the battery voltage will approach the set maximum charge voltage. The charger automatically reduces the charging current to avoid exceeding the set maximum charge voltage.

**** (Charge_step 3) / Ends charging at a suitable point during CV mode:**

CV mode charging will continue to reduce the charging current and stop charging when it drops to the charger's programmed shutdown current value. Alternatively, the user can force the charger to stop charging at any of the above stages.

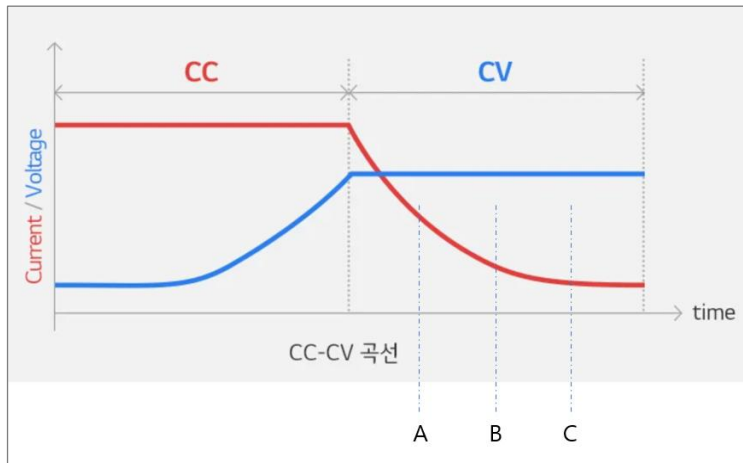

Note :

If you stop charging while charging, the :

The voltage after stopping will be lower compared to the voltage during charging (voltage drop). The higher the resistance of the charging circuit and the higher the charging current, the more severe this voltage drop is. Therefore, terminating the charge at point A will cause more voltage drop than terminating the charge at point C. A large voltage drop indicates that there is not much charge left.

(2) Reasons and solutions for not fast charging :

◇ In "Charge_step 3" above, the size of the charged energy (SOC) is different depending on whether the end point of the charge is point A, B, or C.

In the graph, the area under the red (current) color affects the SOC value 1:1.

This means that disconnecting the charge quickly will result in a lower SOC value. Different charger manufacturers have different cutoff points.

◇ Theoretical charge time

For example, if you have a 100Ah battery and your charger has a charge current of 50A, you

can use the

The theoretical charging time (full discharge → full charge) is

= Lithium battery current capacity (Ah) / charger charging current (A) x correction factor (1.2)

= 100Ah / 50A * 1.2 = 2.4 hours

◇ Why it takes longer than the theoretical charging time :

The larger the resistance of the charging line between 'Charger ↔ Battery' ($R_{\text{Charging Line}}$), the higher the voltage rise on the line ($V_{\text{Charging Line}}$) and consequently the higher the charger output voltage V_{OUT} .

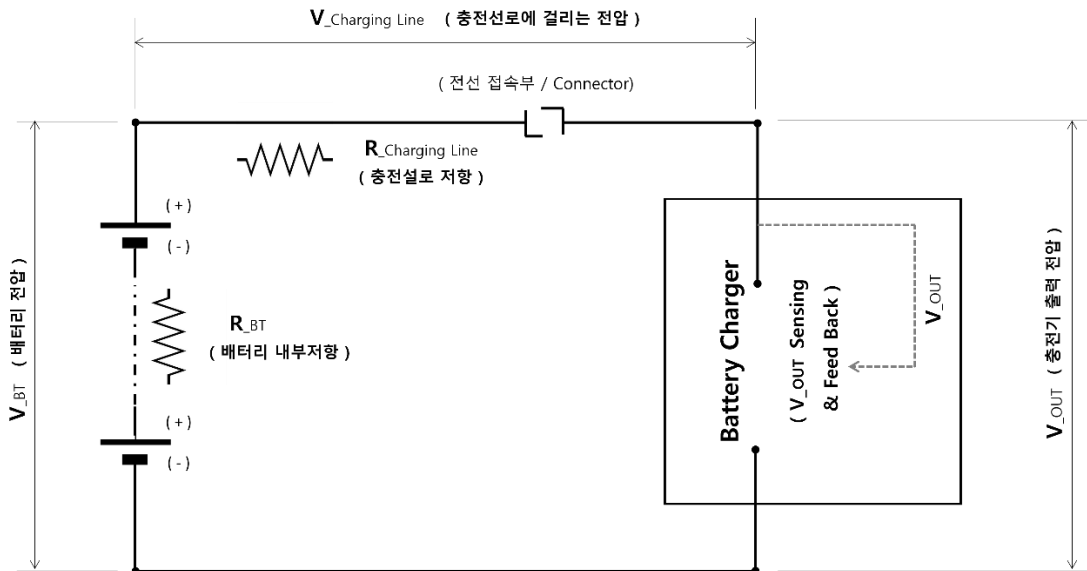

$$V_{\text{OUT}} = (V_{\text{Charging Line}}) + (V_{\text{BT}})$$

The charger senses the voltage just before the charger output connector and recognizes it as the battery voltage.

The voltage rise on the track itself is added to the battery voltage and becomes the voltage at the charger output. In this case, the charger will think that the battery voltage is high even if the battery voltage is low and charge in CV mode, which reduces the current. As a result, the charging time will be longer.

Let's analyze the case where the line resistance is large and the charging current is also large, resulting in a voltage rise of 3V on the charging line.

For example, let's say your charger has a full charge pressure setting of 58V.

$$V_{\text{OUT}} = (V_{\text{Charging Line}}) + (V_{\text{BT}}) = 58V = 3V + 55V$$

The charger sees the battery voltage as 58V, even though it is at 55V, and reduces the charging current.

(In the Charge_stage_3 graph above, the CC interval is shortened, resulting in longer charging time.)

For this reason, it takes longer to charge.

◇ Bottom line: use as thick a wire as possible for the charging wire, and use a large enough capacity for the connection connector → to reduce the resistance across the line. :

20. Add an external control method

〈 This document applies to both the 3500W corded and wireless charger.

20-1. Blue Tooth Wireless Communication

* Note1: Users can purchase and use the commercially available Serial to Bluetooth Converter.



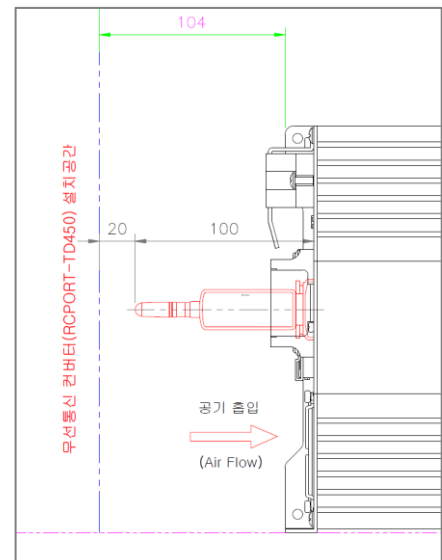

* Note2 : RS485 to wireless communication (Blue Tooth) converters are available from various manufacturers,

Tabos tried out the chipsen.com product (below) and found it to be a good fit.



〈 Figure 3500W Charger Wireless Communication Module Mounting Space

20-1-1. What to bring

	Manufacturer name	Type number	Product description	Remarks / Uses
<p>λ</p> <p>Essentials</p> <p>(Purchased by user)</p>	<p>Wireless RS422/485 Serial converters (adapters)</p> 	<p>RCPORT-TD450 < chipsen.com ></p>	<p>* Connection: D-Sub9-pin (Male / Male)</p> <p>* Protruding length after connection: about 100mm</p> <p>* 1:1 node switching to 1:7</p>	<p>* Connect to the charger</p>
<p>* The pin map of D-Sub9 pin (female/female) of Tabos charger (including wireless charger) and 5V power line are completely matched, so you can just plug it in. (Since 5V communication power is supplied by Tabos charger, there is no need to supply external 5V power to the</p>				
<p>B</p> <p>Essentials</p> <p>(Purchased by user)</p>	<p>Wireless RS232 to USB converter (adapter)</p> 	<p>RCPORT-TD420 < chipsen.com ></p>	<p>* Connection: USB plug,</p> <p>* Length after connection: approx. 90mm</p> <p>* 1:1 node switching to 1:7 multicommunication (up to 7 multicommunications)</p>	<p>* Connect to Host (PC)</p>
<p>Below is a tool for working with the RCPORT-TD450 converter (adapter) by connecting it to a PC to ① change the communication speed and ② pair it.</p>				
<p>③ â</p> <p>Supplies</p> <p>(Purchased by user)</p>	<p>USB Male to 485 Terminal</p> 	<p>3pin or 5pin type is irrelevant</p>	<p>There are several shapes. It doesn't matter what it looks like.</p>	<p>* Connect to your PC</p>
<p>④ â</p> <p>Supplies</p> <p>(Purchased by user)</p>	<p>DSUB9 Female to Terminal</p> 		<p>There are several shapes. It doesn't matter what it looks like.</p>	<p>* Wireless RS422/485 Serial Converter (Adapter)</p> <p>RCPORT-TD450 Connect to</p>
<p>⑤ â</p> <p>Supplies</p> <p>(Purchased by user)</p>	<p>Wire 3core, AWG24 or AWG22</p> 	<p>(Example: UL2464, 3Core, 22awg wire)</p> <p>Length: about 30 cm or more</p>		<p>* For connecting parts 3 and 4</p>

11-1-2. Installation Method and Process

(Step 0) : Consider mechanical design when applying wireless modules

If the Blue Tooth module (wireless converter (adapter)) is surrounded by a conductor, such as a metal enclosure, radio waves will not go out.

Be careful with your choice of reference material. It does not matter if it is surrounded by non-conductors (plastic, ceramic, etc.).

If you're completely encased in metal conductors and can't communicate, use the



You can use a commercially available "Bluetooth module extension cable" to move the antenna out of the way.

(Step 1) :

Go to the manufacturer's website at [chipsen / chipsen.com](http://chipsen.com) and familiarize yourself with the user manual for your model.

These are the minimum precautions for connecting to a Tabos charger.

(Step 2) : Change the baud rate of the 'RCPORT-TD450' serial converter (adapter) attached to the charger to 19200.

Step2-1) Download the 'RCPORT-TD450' MANAGER program from chipsen.com and install it on your PC.

Step2-2) Align the selection switches as shown below.



< Pictured above: connecting to the charger >.

Step2-3) Connect the 'RCPORT-TD450' with your PC using a 'USB to 485 adapter'.

< Connect to a PC using accessories ③, ④, and ⑤ above >.

When finalizing, use the following as a guide to finalize.

3-3. "USB to 485 터미널" 전선 연결--> RS485통신은 아래와 같이 2선식 및 4선식이 있습니다.

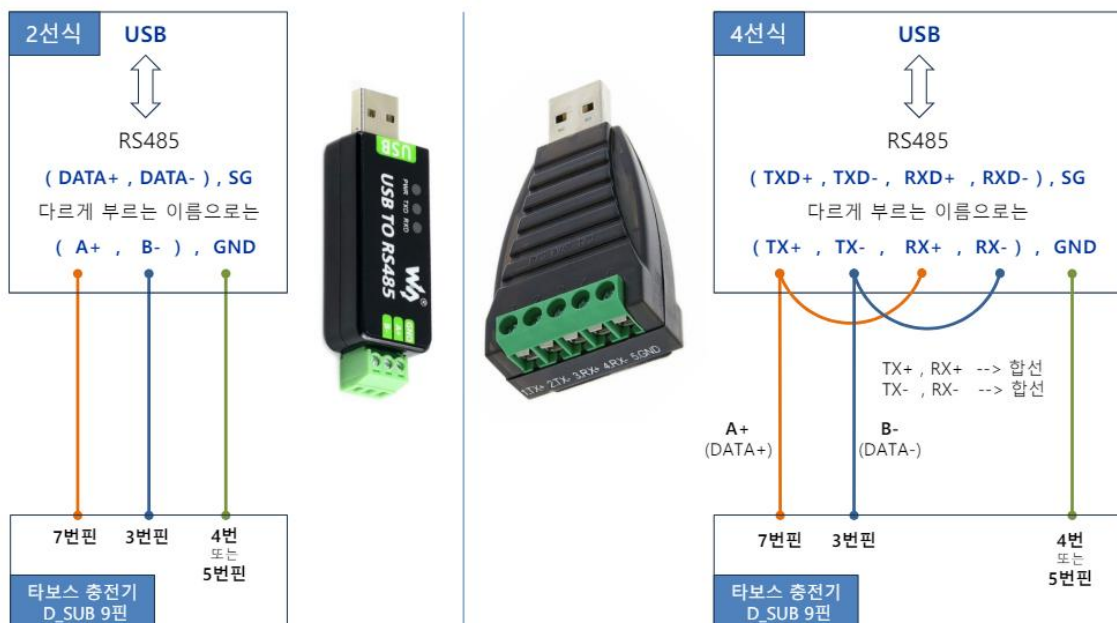

Step2-4) After executing 'RCPORT-TD450' MANAGER, if it connects to PC normally, click
You should see a screen like the one below.

Make sure to set the communication rate to 19200.

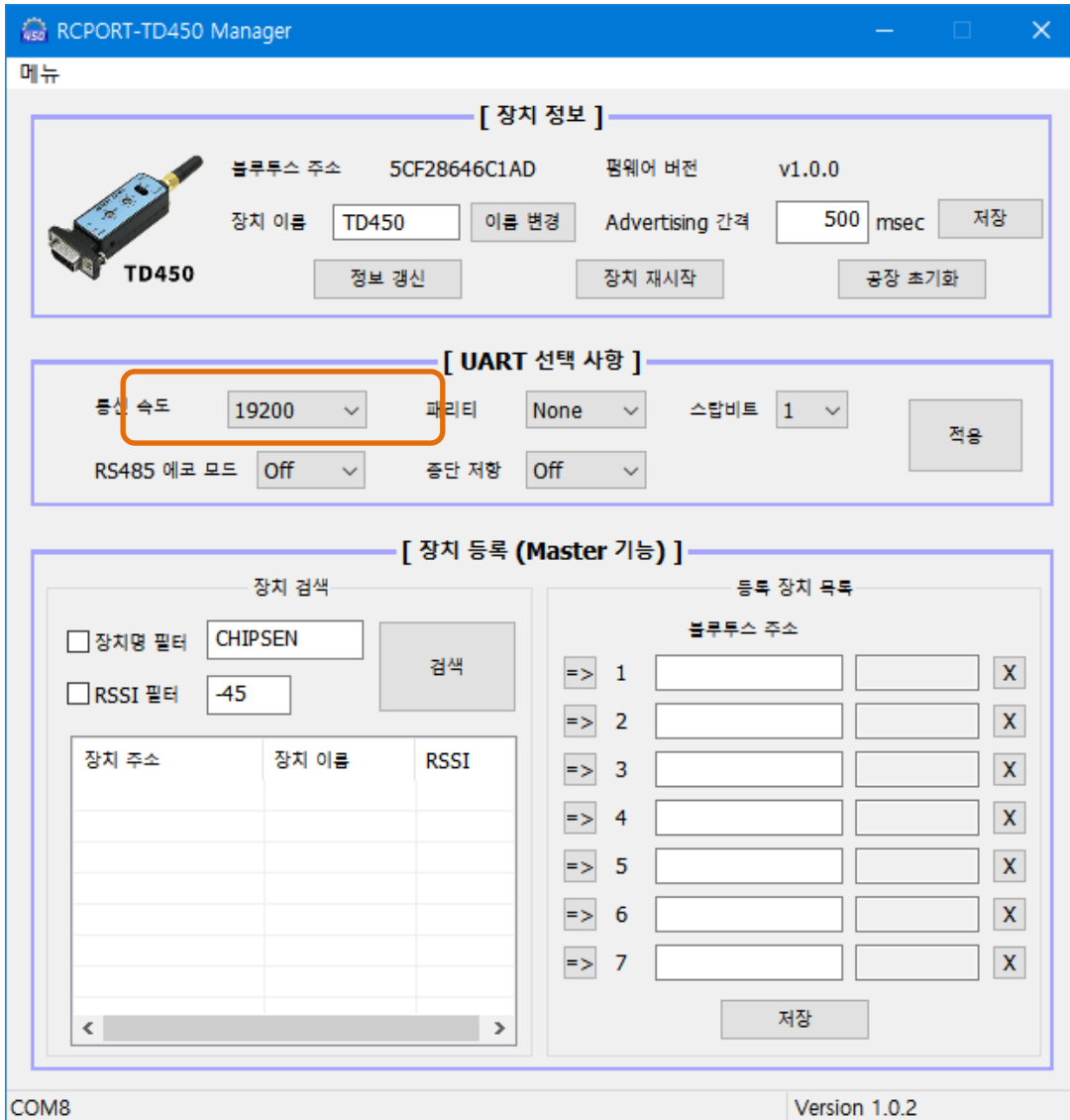

RCPORT-TD450 Manager

[장치 정보]

블루투스 주소: 5CF28646C1AD 펌웨어 버전: v1.0.0

장치 이름: TD450 이름 변경 Advertising 간격: 500 msec 저장

정보 갱신 장치 재시작 공장 초기화

[UART 선택 사항]

통신 속도: 19200 패리티: None 스탭비트: 1 전용

RS485 에코 모드: Off 중단 저항: Off

[장치 등록 (Master 기능)]

장치 검색

장치명 필터: CHIPSEN 검색

RSSI 필터: -45

장치 주소	장치 이름	RSSI

등록 장치 목록

블루투스 주소

=> 1			X
=> 2			X
=> 3			X
=> 4			X
=> 5			X
=> 6			X
=> 7			X

저장

COM8 Version 1.0.2

(Step 3) : 1:1 pairing and communication speed settings

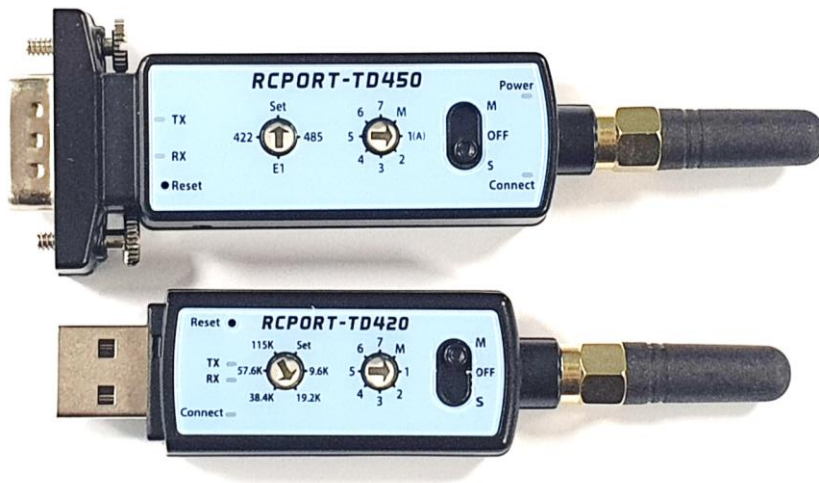

- * RCPORT-TD450' as shown in the photo above,
Set the rotary switch to 'Set'.
Set the Set Device Number rotary switch to '1'.
Set the sliding select switch to 'S', or Slave.
Apply power to the unit.

- * RCPORT-TD420' (attached to the HOST or PC) as shown in the photo above,
Set the rotary switch to '19.2K'.
Set the Set Device Number rotary switch to '1'.
Set the sliding select switch to 'M', or Master.
Connect to a PC. Or power the unit.

- * The pairing is complete when the green signal lamp is continuously lit on both sides of the device.
However, if the green lamp is blinking, pairing is not successful.

- * See the .chipsen.com homepage specification for more detailed usage.

(Step 4) : Enable communication

- * Following the steps above, add the
Change the rotary switch on the RCPORT-TD450 from 'Set' to '485'.

(Step 5) : 1: Multiple pairing Refer to the specification sheet on the → .chipsen.com homepage.

20-2. Ethernet (LAN) Communication Module

〈 This document applies to both the 3500W wired and wireless charger.

*** Recommended products** ← prepared by the user

Name: sLANall RS485 to LAN Serial Converter Basic

Type name: sLANall

Manufacturer: SystemBase, Inc. / sysbas.com

How to use: See manufacturer's website



Caution: As shown in the image below, the pinouts for the "sLANall" product and the D_SUB 9-pin connector on the charger are different. Therefore, you must create your own adapter cable bundle to match.

Do not plug the sLANall converter directly into the TABOS charger's D_SUB 9-pin connector.

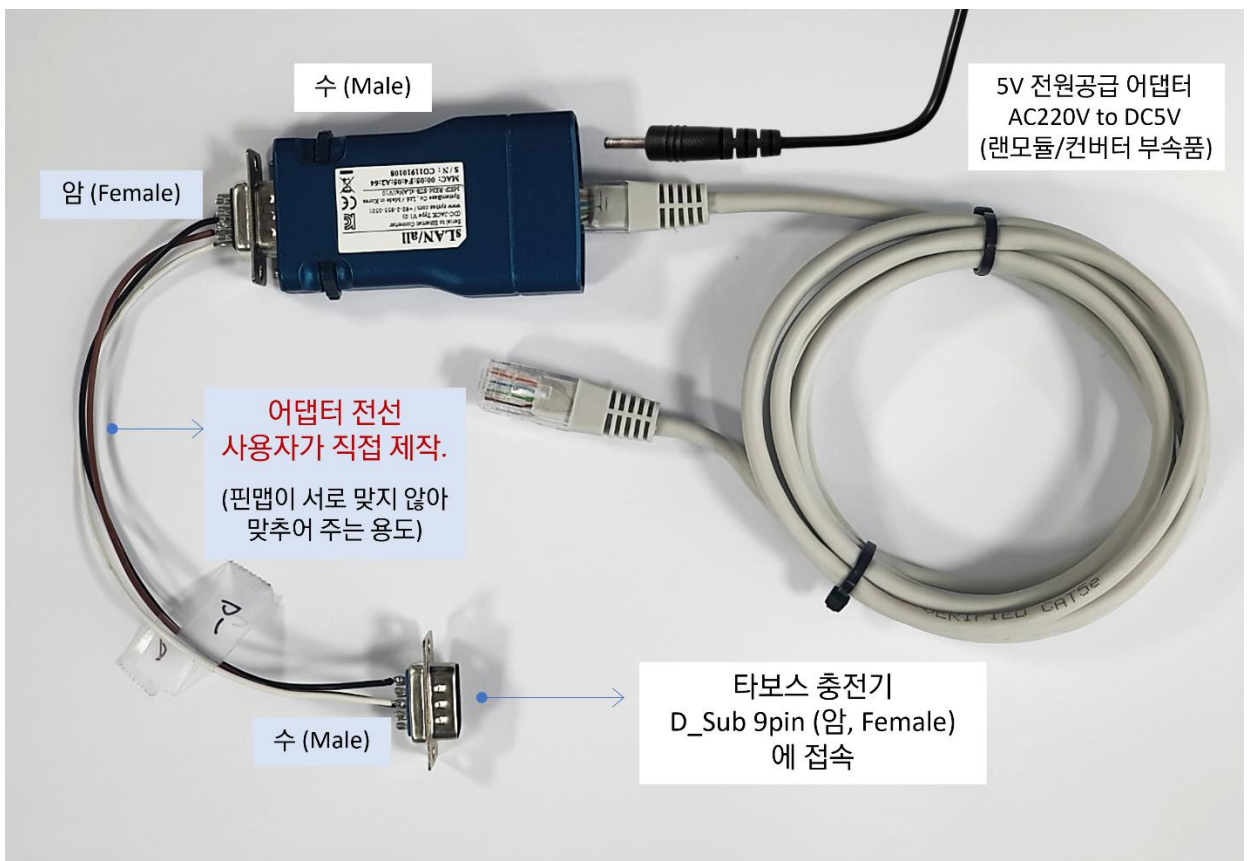

2) Below: TABOS charger pin map / D_Sub 9-pin / Female

RS485 PIN MAP		
핀번호	이름	설명
1	Vcc	+5V / 통신전원
7	DATA+	RS-485 POSTIVE
3	DATA-	RS-485 NEGATIVE
4,5	GND	GROUND

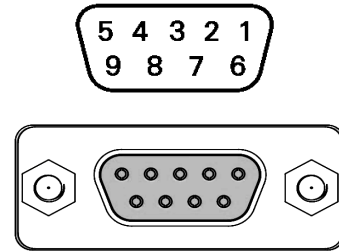

*Note:

Pins 4 and 5 are short-circuited. You can use either pin 4 or 5 as GND.

Pin 1 (Vcc) is not connected. It is not used.

*The TABOS charger has a pin that outputs 5V as shown above, but the sLANall converter does not have a 5V pin assigned, so the only way is to use a separate 5V converter as shown in the picture on the above page.

3) Below: sLANall pin map / D_Sub 9-pin / Male

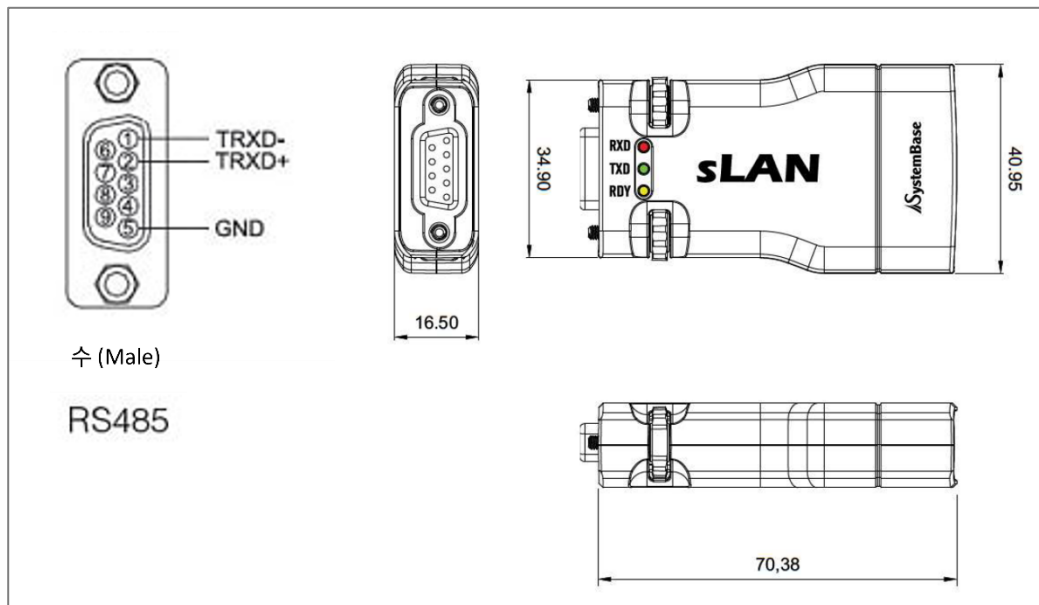

< Caveats

Normally, you don't need to set a terminating resistor if the communication distance is short.

Through our own testing, we have found that the communication quality of this communication conversion adapter depends on whether the termination resistor is set or not.

Important: Set the termination resistance (RT) during RS485 communication setup in the LCD window of the Tabos charger. _____

21. Charger Control Panel (optional) specifications/drawings and usage

- Reference : Export HS Code: 8537.10.9000

21-1. Need and Role of the Control Panel



You can check the charging status through the indicator light (Standby, Charging, End of charge, Error).

The emergency switch can be used when you want to stop charging immediately, including in case of emergency (smoke, fire, etc.).

Note that most battery fires occur while charging.

- ③ There is a spare connector for the user to attach an additional DC fan (the fan is only powered during charging).
- ④ There is a port for the user to attach an additional proximity sensor to confirm that the AMR has arrived at the charging station. When the sensor detects that the AMR has arrived at the charging station, the control panel automatically gives the command to start charging.

〈For wireless chargers only: below〉.

In this case, no charging command is given to the faucet controller, and the faucet controller becomes a passive slave.

☞ If you need this approach, please contact Tabos. There are additional steps you can take

21-2. Photos and drawings



〈 Control Panel Drawings 〉 Control Panel Drawings

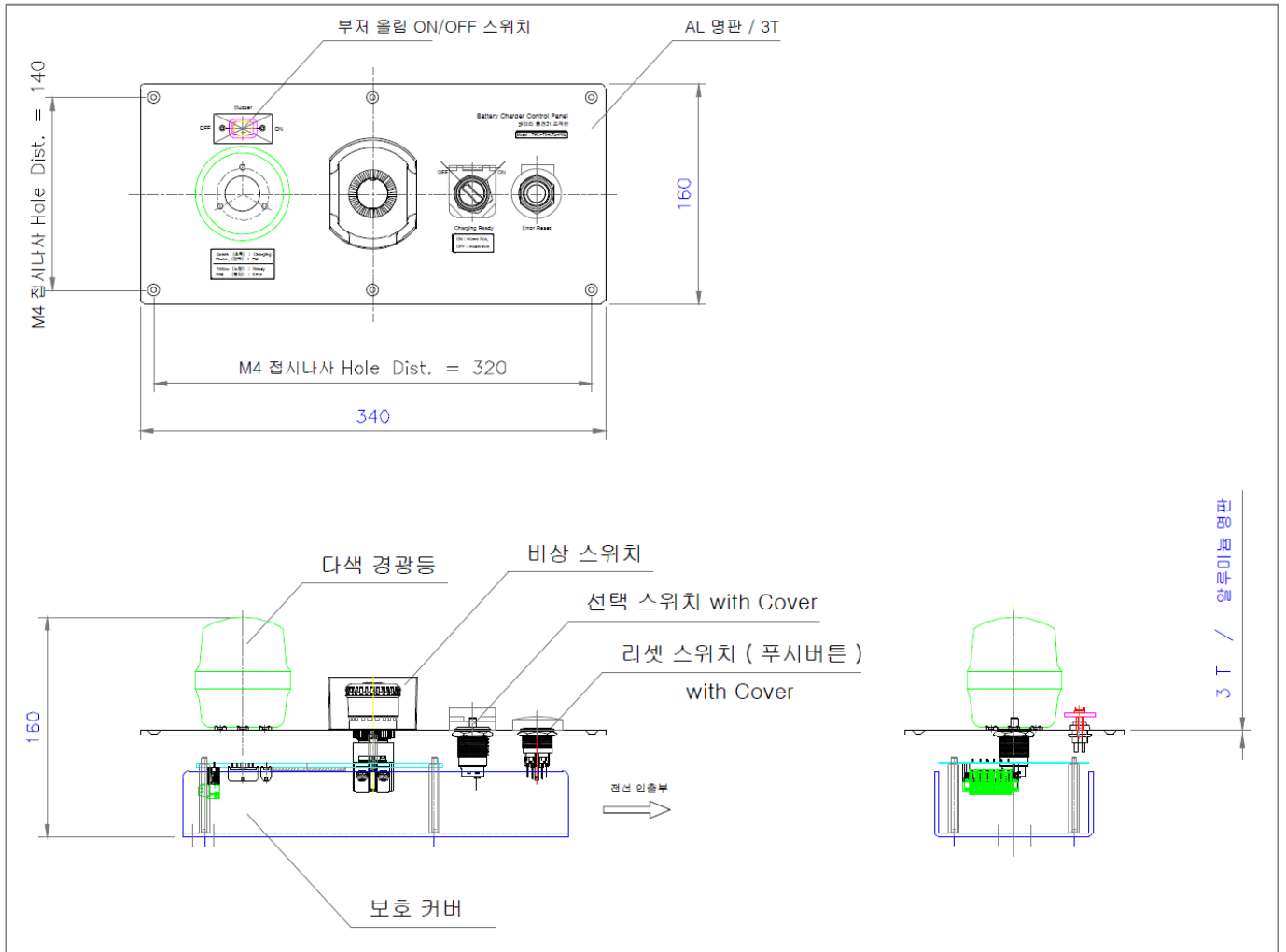

21-3. Control Panel Functions

And on the control panel

1) Start/stop charging can be commanded with the selector switch (rotary switch).

When configuring as a charging station for robots (AMR, AGV)

When the selector switch is placed in the ON position, the robot arrives at the charging station and contacts the battery charging terminals (charge contactors).

The charger automatically detects the battery connection and charges it automatically.

If the charging terminal falls off, it stops charging and does not output electricity to the charging terminal (as a safety measure).

2) Error reset can be done with a pushbutton switch.

3) Emergency stops can be made with an emergency switch:→ **(N.C. Type)**

4) A multi-colored LED lamp indicates status.

Green: Charging / Green blinking: Full / Yellow: Waiting to charge / Red: Error status

5) Buzzer: There's a switch next to the error tone/buzzer that you can turn off if it's too loud.

6) Additional Features ① : There are two Molex connectors that can drive two DC24V FANs.

Use: If you are building this charger enclosure and installing only this control panel on top of it, Fans can be run for internal ventilation of the enclosure.

This FAN will run when the charger is running and for a period of time after the charger stops running for additional cooling.

7) Additional Function ② : Allows you to connect the sensor to the main control panel.

The way it works is that the connected sensors detect the arrival of a robot (AMR) that wants to charge and use this signal to instruct the charger to charge.

When applied to a wired charger, it works in Manual Mode. / Does not work in Auto Mode.

When applied to a wireless charger (WPT), it works in Remote. . / Does not work in Local Mode.

The following applies to wireless chargers only-----

(Note when applying to wireless chargers)

Special care must be taken when connecting the arrival detection sensor of the driving robot light to the wireless charger (WPT).

This is because the electromagnetic waves emitted by the TX coil pad may affect the sensor, causing malfunction or damage to the sensor. Therefore, if you plan to use this sensor, please contact TABOS for technical consultation.



*Example: Type of sensor available (magnetically shielded type required) and distance from TX coilpad, Consulting on how to block TX Coilpad electromagnetic interference.

21-4. (Optional Product) Control Panel Specification List

Tabos Development / Direct Production

(Made in Korea)

No	Item		Model Name : TWC-TX-STA-PNL	Remarks
1	Authentication	Apply the ACDC converter's CB, CE, and UL certifications instead.	Equipped with a 15W output converter that converts AC220V to DC12V. Converter Type: RS-15-24 / CE, CB, and UL Certified	
2	Purpose	Applicable devices	(1) Tabos Wireless Charger Transmission Controller (TWC-2500W-A-TXCOIL) (2) Tabos Wired Charger (TC-3500W-)□□□□ (3) Tabos Wired Charger (TC-7000W-)□□□□	Connected to a battery charger Perform charge command and monitoring functions
3	Input power specifications	RMS value	Single-phase 110VAC~ 240VAC / 50~60 Hz , current 0.1A at AC220V Connector: Pigtail Plug	
4	System Power		DC 24V (powers all sensors, switches, alarms, and external FANs)	Isolated Converter / OutPut :24V 15W, 0.625A
5	Accessory wire length	Length (m)	① Enable wire and ②DIO wire→ 0.96m each ② AC power input pigtail cable→ 1.7 meters or more	Secure the bundle of wires with cable ties from the clear back cover to the The length measured from the point of tying
6	Size and weight	mm, Kg	(L) 340 x (W) 160 x (H) 160 mm (excluding cable dimensions), Weight: 1.5 Kg (with cable)	
7	Switch	Emergency switch	Emergency stop charger / *Note: This will emergency stop charging, but not the FANs can run in emergency shutdown conditions. No polarity.	If the emergency switch is set to Directly connected to the Enable switch.
8		Buzzer switch	Enable buzzer notification sound (ON/OFF control)	Switches with direct hardware connection to the light
9		Rotary direct switches	Charging ON / OFF	Operation via Digital I/O (DIO) signals
10		Pushbutton switches	Clear errors	

No	Item		Model Name : TWC-TX-STA-PNL	Remarks
11	Warning lights (Content by color)	Tri-color LED (red, amber, green)	Red: Error / Yellow: Standby / Green: Charging / Green Blink: Full	
12		FAN drive connector / FAN1, FAN2 (2 pcs)	For DC24V FAN drive, (0.15A/channel) x 2 channels (Runs when charging, and runs for another 5 minutes when charging ends) 2POS Connectors (1 +, 2 -), User-prepared connector : Molex Housing : 3515502 , Socket Crimp : 0008700056, Wire : 22~24AWG	Something that users can use as needed. The additional uptime after charging ends is Subject to change and adjustment without notice.  (User-prepared connector)
13	For users Spare connectors	Connector for Charge Command Sensor / J19 (1 pc.) Sensor Input, Contact Input	Users can use this signal to control charging ON/OFF by installing a sensor or contact (relay). (Method 1): Sensor Installation: DC24V Power Supply, PNP / N.O. Type (Method 2): Contact Input: Pins 1 & 2 contact input, Pin 3 unused. -◇ Contact Short = Charging Command. 3-POS Connector (SIG 1, 24V 2, GND 3), Housing : 05110303 , Socket Crimp : 503518000, Wire : 22~24AWG Here, 24V is the external sensor power supply from this device. *Note: The above (Method 2) is applicable to units shipped from October 2025 onwards. It is not applicable to units shipped before that date.	When using this control panel for a charging system that charges a mobile robot, it can be used to detect if the mobile robot has arrived at the correct location. When the sensor is detected, a charge ON command is issued.  (User-prepared connector)

21-5. Wiring Method Details

The cable that comes with the Tabos add-on like the one pictured below is attached to this charger's

- 1) DIO connector (for charging commands and lighting the charge status signal lamp) and
- 2) Plug it into the Enable connector (for the emergency switch),
- 3) Plug in the AC220V (0.15A current draw) pigtail power connector.

< Wiring Diagram

TWC-TX-STA-PNL

(실물 사진 및 결선 방법) 2023.11.27

출력 전선

- 1) AC220V 돼지코 플러그 / 0.1A ,
- 2) DIO (Digital Input Output) 전선 코넥터 <---> 충전기(또는 WPT_송전제어기) 본체의 DIO 코넥터와 접속
- 3) Enable 전선 <---> 충전기(또는 WPT_송전제어기) 본체의 Enable 코넥터 (나사식 단자)에 접속



(결선 방법)

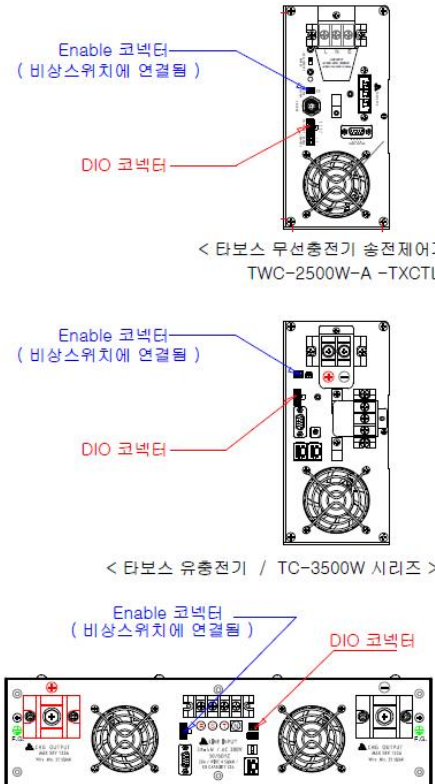

< 타보스 무선충전기 송전제어기 >
TWC-2500W-A-TXCTL

< 타보스 유충전기 / TC-3500W 시리즈 >

< 타보스 유충전기 / TC-7000W 시리즈 >

21-6. Spare connector details for user (FAN drive, charge command sensor)

1) Fan1, Fan2 drive connector: This connector is powered only during charging, but after the charge expires, it is powered for an additional period of time to increase cooling performance.

2) J19 connector: Sensor connector required when a robot (AGV, AMR) detects that it has arrived at the charging station and uses this signal as a charging command signal (Normal Open type PNP sensor can be installed)

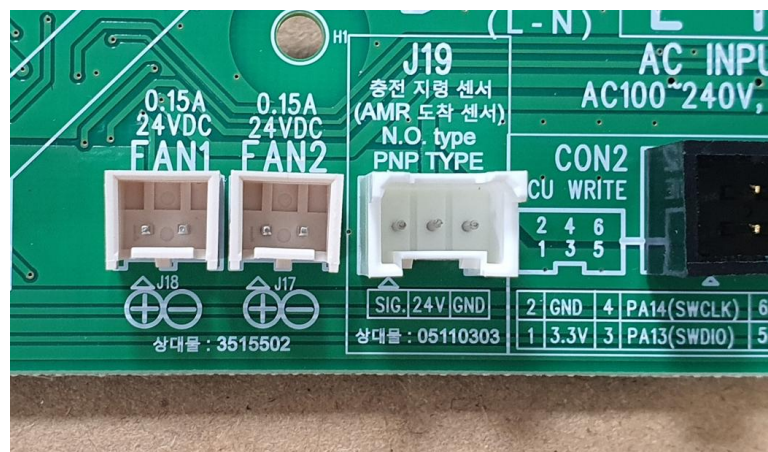

21-7. How to set the LCD window for operating this control panel

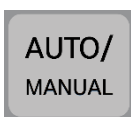

For wired chargers [or wireless chargers], click on the LCD window of the Transmission Controller (TX) and select the

Use the Auto/Manual button to set it to Manual.

(However, if you are in Auto mode instead of Manual mode, you can only monitor, but the alarm will still work).

21-30. Diagnosing and resolving faults

Case 1) : The control panel lamps (both warning lights and switch lights) flicker throughout, and the operation is strange.

Cause and solution):

The control panel is equipped with an SMPS that converts AC220V to DC24V.

This SMPS is overloaded, causing the output to shut down periodically.

This can be caused by a short circuit somewhere on the DC24V output or an overload.

In one case, the FAN connected to the FAN connector was shorted and failed.